





Installation and Operating Instruction for B.E.G. DALI compact solution PD4-M-DAA4G

1. Product information

- Flexible compact DALI solution designed for conference rooms, training rooms and classrooms
- High-sensitivity occupancy detector with the capability to address up to 64 DALI electronic ballasts automatically, with segmented control via 4 groups
- 3 lighting zones:
 - A for main lighting with segmented constant light regulation via 3 DALI groups and offset control
 - B for lectern or blackboard lighting via separate DALI group
 - C for lectern or blackboard lighting via integrated switching relay
- High performance switching relay with various operating modes, e.g. DALI cut-off function, HVAC, blackboard lighting, etc.
- Quick commissioning and maintenance processes with smartphone/tablet app (Android, iOS) - PC tool not required
- Manual switching and dimming available with conventional switches
- Extension of detection area possible with slave devices
- Plug & Play with broadcast telegrams and basic functions. Full range of functions can only be activated with the **B.E.G.** IR-Adapter and a smartphone or tablet (Android, iOS)

2. Safety advice

-  **Work on electrical equipment should only be undertaken by qualified electricians or by trained personnel under the instruction and supervision of a trained electrician, according to the regulations for electrical installation**
-  **Turn off the mains supply before fitting**
-  **This device is not to be used to isolate other equipment from the mains supply**
-  **After inserting the connection cable, fit the supplied cover to the detector**
-  **The push button inputs and the D+/D- terminals must not be connected to the mains supply**

3. Operation

3.1 General

The PD4-M-DAA4G is a highly sensitive ceiling-mounted occupancy detector based on passive infrared motion detection, with integrated DALI controller, DALI power supply and push button control. If people, animals or other heat sources move within the detection area, the detector can dim and switch any DALI-controlled electronic ballast-driven lights, taking account of ambient light levels, such that a predefined room lighting level is constantly maintained. Slave devices, type PD4-S-DAA4G, can be installed to expand the detection area.

See *FIGURE 3.1, Detection diagram*

3.2 Groups and lighting zones

See *Figure 3.2, Grouping principles*

There are three lighting zones (areas for a lighting purpose) available which can be parameterised by means of a predefined grouping principle of the integrated DALI control unit and an operating mode of the integrated relay.

3.2.1. Lighting zone A (main lighting)

The PD4-M-DAA4G allows you to compensate for differences in brightness due to daylight coming from one side of a room fully automatically, using segmented constant light regulation in lighting zone A across 3 groups. Fittings with DALI electronic ballasts are thus grouped as follows:

- Group 1: for areas with little daylight
→ areas away from the windows
- Group 2: for neutral areas
→ for example the central lighting run
- Group 3: for areas which may have strong daylight
→ areas near the windows

Groups 2 and 3 can be set up with a negative offset between 0% and 25%, and will then scale back their lighting output in relation to Group 1. In extreme lighting situations (very bright daylight or no daylight), both offset settings will be automatically reduced to 0%.

3.2.2. Lighting zone B and C (lectern or blackboard lighting)

For teacher or blackboard lighting, lighting zone B (via DALI group 4) and/or lighting zone C (via integrated relay) are available. In lighting zones B and C, automatic constant light regulation is disregarded.

3.3. Integrated relay with operating modes

There are 7 different operating modes available on the integrated bistable relay (potential-free, NO). These cannot be combined:

- “Cut-off” - standby current consumption of connected DALI electronic ballasts is automatically minimised
- “HVAC” - heating, ventilation and air-conditioning units are automatically controlled for energy efficiency, depending on motion detection in the room, using a separately-set follow-up time
- “Zone C” - activates lighting zone C with push button input C, for example to provide teacher or blackboard illumination without a DALI electronic ballast. The automatic mode depends on the settings for lighting zone B (Group 4).
- “CdS” - “cadmium sulfide” - relay works as photo electric switch
- “None” for “no function” - relay is not actuated
- “Alarm impulse” (via operating mode HVAC) - The relay only closes for 2.5 seconds if at least 3 movements have been detected during a time period of 9 seconds. This function can be used to display a presence in the room on external visualisations. (Warning: The device does not fulfil the requirements of DIN EN50131-2-2 and therefore cannot be used in professional intrusion detection systems.
- “Impulse function” (via operating mode HVAC) - The impulse function can be used to control external HVAC systems. All 9 s will be set an impulse lasting 2.5 s

See *Figure 3.3, function diagram*

3.4. Full automatic / semi-automatic mode

Lighting zones A and B can be set individually to full automatic or semi-automatic mode. Lighting zone C always works with the settings from lighting zone B. In full automatic mode, the light is turned on automatically when motion is detected and ambient light is low enough, and turned off after an adjustable follow-up time and/or when ambient light is bright enough. Semi-automatic mode works in a similar fashion, except that switching on the lights must take place via a push button (→ manual ON/ auto OFF).

3.5. Push button functions

Conventional NO push buttons can be used.

A short press on all three push buttons, A, B and C, turns the light in each lighting zone on or off. A long press (> 2 seconds) on push buttons A and B leads to manual dimming (brightness up or down - another long press reverses the dimming direction).

Special feature in full automatic mode: if you want to use a short press to deliberately switch off the light in the room, for example to show a film or set up a projector, the light remains off until the follow-up time has expired.

3.6. IR-Adapter

Lighting zones can only be parameterised sending infrared signals via Smartphone app. Factory setting of the detector is broadcast mode (white LED shines permanently). So it is possible to check all DALI bus connections and pushbutton connections without parameterising. To send infrared signals via the Smartphone or a tablet, an IR-Adapter (part no. 92726) is required, which must be charged periodically, and has to be plugged in to the audio socket of the Smartphone or tablet.

See *FIGURE 3.6 IR-Adapter*

4. Wiring

See *FIGURE 4, Wiring diagram*

4.1. DALI

For wiring the DALI bus, standard electrical installation cabling can be used (e.g. NYM-J 5x1,5). The recommended wire gauge is 2x0,5 mm² (up to 100m), 2x1,0 mm² (up to 200 m), 2x 1,5 mm² (up to 300 m). A total length of 300 metres must not be exceeded. The DALI bus is factory-fitted with reverse polarity protection.

4.2. Push buttons

For push button connections, also standard electrical installation cabling can be used (e.g. NYM-J 5x1.5 or J-Y(STY)-8x2x0.28), with a minimum wire gauge of 0.28 mm² and a maximum length of 50 metres. For use in industrial environments, it is recommended to separate all pushbutton wires from other loads and to guide them in a wired cable.

4.3. Connecting terminal

The connectors are suitable for solid wires with a cross-section of up to 2.5 mm². Ferrules must be used with stranded wires.

4.3.1. Connecting for false ceiling

The ceiling-mount version of the PD4-M-DAA4G is fitted with 2 removable multipole screw terminals. When installing the wires, these two terminals can each be pulled out. After connecting the wires, it is important that the terminals are fixed back onto the support and into each recess. Caution: only use the terminals supplied. These are designed so that it is not possible to reverse polarity or to swap them.

4.3.2. Connecting for surface

The surface mount version of the PD4-M-DAA4G is fitted with 2 multipole screw terminals on its socket. Fastening of the detector to the socket is designed such that the contact pins are automatically connected and it is not possible to reverse polarity or to swap them.

5. Mounting

5.1. General

The ideal mounting location is inside, 2.5 to 3 metres high, on the ceiling. Ventilation units and other heat sources (e.g. copiers) should not be in the immediate vicinity of the detector, as otherwise “false alarm” motion detection events may be triggered.

5.2. Light sensor

The exact mounting location of the detector depends on two things. One is the area in which motion is to be detected. The other factor that influences detector position in the room is that light measurement has to take place in the lighting area of DALI Group 1 (potentially dark areas). The exact mounting location of the detector does not have to be precisely above the lighting area of DALI Group 1, because of the vertically-adjustable (by max. 30°) light sensor on the cover ring, and because the detector can be turned in all directions horizontally. Normally, it is recommended that the detector is mounted centrally in the room, near or adjacent to the DALI Group 1 lighting area.

5.3. Ceiling installation variant

First, a round opening 100 mm in diameter must be made in the ceiling. After properly connecting the cables, the detector is inserted into the opening and if necessary turned on its axis until the light sensor can be pointed to the probable darkest area of the room. The detector is then fixed with screws through the mounting bracket.

See *FIGURE 5.3, Ceiling mounting*

5.4. Mounting SM

The detector must be fixed on a smooth, solid surface. First, 2 holes must be drilled in the ceiling, at a distance of 67 mm from each other, such that an imaginary straight line between the two drilled holes points to the probable darkest area of the room (e.g. the wall opposite the window side). Later adjustment of the light sensor's horizontal direction is still possible after fastening (can be turned by about 80°). Before mounting, the lens must be removed. Turn the lens about 5° anticlockwise and remove it. After properly connecting the wiring, the detector must be fixed with 2 screws. Then reattach the lens, turning it clockwise.

See *FIGURE 5.4 Surface mounting*

6. Self-test cycle

In the first 60 seconds from when the mains voltage is turned on, the detector runs through a self-test cycle. During this period, the device does not react to movement.

7. Commissioning without IR-Adapter

The PD4-M-DAA4G can also be put into service with basic functionality without changing any settings. Out of the box, the detector works in Broadcast mode (white LED shines permanently), which can only be changed over to Group mode with the remote control (smartphone or tablet + IR-Adapter + app) and the command “UNLOCK”. All push buttons are activated in Broadcast mode (switching and dimming).

See *FIGURE 7, Potentiometers and DIP switches*

The following settings can be made via potentiometer and DIP

switches:

A



Cut-off: Standby consumption of connected DALI electronic ballasts is automatically minimised / **HVAC (5,10,15):** light-independent HVAC occupancy control / **HVAC (30,40,50,60,120):** light-independent HVAC occupancy control with 5 min. switch-on delay / **OFF:** No relay control

B



Moon: Night mode (< 10 lux) / **Set value in lux:** 100,150,200,300,400,500,700,900 / **Sun:** Day mode (no constant light regulation, "too dark" detection always active)

C



Test: Each movement, regardless of ambient light levels, switches the light on for 1 second, then off for 2 seconds (PLEASE NOTE: Test mode is only possible if potentiometer B is not in the "Sun" position) / **Follow-up time for lighting zones in minutes:** 1,5,10,15,20,25,30,60

Nr.	Parameter/Function	Description
DIP 1.	Soft Start	ON: initially to 10% at switch-on, then rising to set value / OFF: initially to 100% at switch-on, then falling to set value
DIP 2.	Init-Light	ON: when voltage is applied to detector, all lights turn on at 100% / OFF: when voltage is applied to detector, all lights are off (0%)
DIP 3.	Auto-ON	ON: full automatic broadcast or lighting zone A / OFF: semi-automatic broadcast or lighting zone A

8. Factory Reset

Factory settings inclusive Broadcast-modes can be restored at any time in the following manner (warning - all previous settings will be lost):

1. Turn on mains supply if not already on
2. Turn "TIME" potentiometer to "Test" (if the potentiometer is already in the "Test" position, it must first be turned to another position)
3. Turn "LUX" potentiometer to "Sun" (if the potentiometer is already in the "Sun" position, it must first be turned to another position)

When all LEDs blink for approx. 3 seconds, activation of factory settings inclusive Broadcast-Modus has been successfully completed.

See FIGURE 8, LED and light sensor positions

9. Blocking out sources of interference

In order to block out sources of interference, for example copiers or air conditioning outlets, there is an option to fit clip-on covers to the lens.

See FIGURE 9, Covering

10. LED Indication

Nr.	Indication	white	green	red
1	Self-test cycle (factory setting)	Blinking	Blinking	Blinking
2	Self-test cycle (not programmed)	-	-	Blinking
3	Self-test cycle (programmed via IR)	-	-	Fast blinking
4	Self-test cycle (not programmed + double locked)	-	Blinking	-
5	Self-test cycle (programmed via IR + double locked)	-	Fast blinking	-
6	Too bright	-	Blinking	-
7	IR signal OK	Short ON	-	-
8	DALI configuration mode/ grouping process	ON	ON	ON
9	DALI auto-addressing	Fast blinking	Fast blinking	Fast blinking
10	Broadcast mode	ON	-	-
11	Unlocked (parameters + commands)	-	ON	-

12	Movement detected	-	-	Short ON
----	-------------------	---	---	----------

11. Smartphone app information

11.1 Preparing smartphone (Android, iOS)

Please install the app "B.E.G. Remote Controls", available in the respective App Store. Depending on the end device it can be necessary to update the operating system. For current system requirements see application description.

11.2 Preparing IR-Adapter

The IR-Adapter has an integrated rechargeable battery for power supply. Please charge the adapter first by means of the micro USB cable (included in delivery). The battery being charged, The red LED switches off when battery is full.

11.3 Preparing App

Open the app and search for remote control "IR-PD-DAA4G" or the product "PD4-M-DAA4G-FC". Open the remote control.

11.4 Connect Adapter with smartphone

Plug the adapter in to the audio socket of your Smartphone or tablet. You must ensure that the IR-Adapter is fully inserted into the socket.

Please note that covers or cases may partially block a correct insertion of the adapter into the audio socket.

Set the volume of the audio socket to maximum in order to ensure a sufficient transmission range of the IR signal.

In the app, a notification at the upper side of the user surface changes from red (no adapter found) to green (adapter connected).

11.5 Explanation buttons

Modi

UNLOCK



- Tab DALI: Starts DALI configuration mode („open“)
- Tab COMMAND / PARAMETERS: Starts programming mode („open“)

LOCK



- Tab DALI: Finished DALI configuration mode („closed“)
- Tab COMMAND / PARAMETERS: Exits programming mode („Closed“)

DOUBLE LOCK



- Tamper Protection is activated when it is pressed within 5 seconds after LOCK.
- Can be deactivated via a factory reset.
- Can be removed again via Factory Reset or the following procedure:
 - > 1. Disconnect power
 - > 2. Reconnect power
 - > 3. After at least 31 and at most 59 seconds, disconnect power again
 - > 4. Reconnect power.

Tab-DALI

SEARCH



- Open: Applies to all connected DALI ECG: Deletes old addressing / groupings launches new auto-addressing, then switches automatically to the group assignment process

ADD



- Open: service mode - Only applies to all connected, factory-new DALI ECG (Factory-new = With short address „FF“): Starts Auto-addressing, then switches automatically to the group assignment process

NEXT



- Open: Starts group assignment process of all addressed DALI ECG
- In the group assignment process: Find the next to be grouped DALI ECG

BACK



- Open: Starts group assignment process of all addressed DALI ECG
- In the group assignment process: Find the next to be grouped DALI ECG

G1, G2,

G3, G4



- Open: Show / Check groupings
- In the group assignment process: Saves selected group of flashing DALI ECG
- Group 1 for light zone A -> dark areas (wall side)
- Group 2 for light zone A -> neutral regions
- Group 3 for light zone A -> light areas (window)
- Group 4 for light zone B -> blackboard lighting

RESET



- Open: Broadcast Reset - Sets the DALI ballasts to default values (except short address)

Tab Command

SWITCH



- Closed / Open: Turns light zone A / OFF

EYE



- Closed: Closed dimming
- Open: Saves the current light level

TEST



- Closed: Start test mode
- Open: No function

RESET



- Closed: Closed test mode and resets all timers
- Open: Factory Reset - Overwrite all settings with factory program and disabled protection against manipulation (Note: Broadcast mode is only about hardware reset „sun“ + „test“ recoverable)

DIM UP



- Closed: Fast dimming up to MAX
- Open: Slow dimming up to MAX

DIM DOWN



- Closed: Fast dimming down to MIN
- Open: Slow dimming down to MIN

SHIFT +



- Closed: No function
- Open: LUX setpoint will be minimal increase

SHIFT -



- Closed: No function
- Open: LUX setpoint will be minimal reduced

Tab Parameter Factory setting

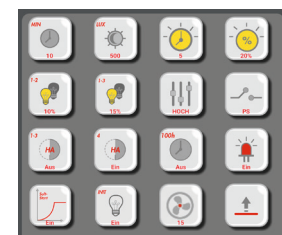















- Closed / Open (long press): Opens the dialog of the respective parameter
- Closed (short press): No function
- Open (short press): Sends each parameter individually to the detector

SEND ALL



- Closed: No function
- Open: Send all in the app bundled set parameters to the detector

Functional descriptions

	<p>TIME</p> <ul style="list-style-type: none"> - Follow-up time for all Light zones in minutes - 1, 5, 10, 15, 20, 25, 30, 60
	<p>LUX</p> <ul style="list-style-type: none"> - Brightness level - Setpoint in LUX - Moon(<10) / 100, 200, 300, 400, 500, 700, 900 / Sun(>0)
	<p>ORIENTATION LIGHT MODE</p> <ul style="list-style-type: none"> - Orientation light - mode - OFF / Follow-up time in minutes: 5, 10, 30, 60 / AN - Note: ON means Continuous operation and leads to fully automatic operation in light zone A
	<p>ORIENTATION LIGHT LEVEL</p> <ul style="list-style-type: none"> - Orientation light intensity in % - 10, 15, 20, 25, 30
	<p>OFFSET G2</p> <ul style="list-style-type: none"> - Damping of group 2 relative to group 1 in% - 0, 5, 10, 15, 20, 25
	<p>OFFSET G3</p> <ul style="list-style-type: none"> - Damping of group 3 relative to group 1 in% - 0, 5, 10, 15, 20, 25
	<p>R1 OPERATING MODE</p> <ul style="list-style-type: none"> - Mode of the integrated relay - PS: „Power Supply“ Cut-off-function minimized power consumption of DALI ECG - HVAC: Control heating, ventilation, air energy efficient - BB: „Black board“ blackboard lighting (light zone C) - CdS: „Cadmium sulfide“ Photo electric switch
	<p>SEMI A</p> <ul style="list-style-type: none"> - Semi-automatic mode for light zone A (G1-3) - OFF, ON
	<p>SEMI BC</p> <ul style="list-style-type: none"> - Semi-automatic mode for light zone B (G4) and C - OFF, ON
	<p>BURN-IN</p> <ul style="list-style-type: none"> - 100-hour function for burning certain lamps - OFF / 25h, 50h, 75h, 100h
	<p>LED</p> <ul style="list-style-type: none"> - LED display - OFF, ON
	<p>SOFT-START</p> <ul style="list-style-type: none"> - Soft start for light zone A and Broadcast - OFF, ON
	<p>INIT-LIGHT</p> <ul style="list-style-type: none"> - Init Light for all light zones and broadcast - OFF, ON
	<p>HVAC</p> <ul style="list-style-type: none"> - HVAC Fine adjustments and their modes - Impuls / Follow-up time: 5, 15, 30, 40, 50, 60, 120 / Alarm

12. Addressing and formation of groups

Before groups are formed, it is recommended that you draw up a plan showing the grouping of all DALI electronic ballasts in the room. Grouping principles for the PD4-M-DAA4G are explained in section 3.2.

12.1 Step 1: Broadcast Reset

Important note for slave operation: connect slave devices only after setting up addressing, or else ensure that, while auto-addressing takes place (all LEDs blinking quickly), no-one remains in any slave device's detection area, so that no motion detection events are sent to the master.

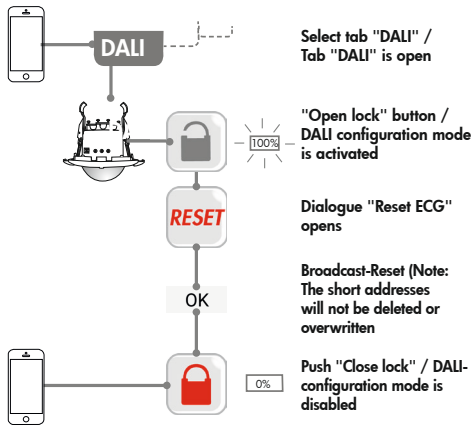

12.2 Step 2: Set up addresses

Important note for slave operation: connect slave devices only after setting up addressing, or else ensure that, while auto-addressing takes place (all LEDs blinking quickly), no-one remains in any slave device's detection area, so that no motion detection events are sent to the master.

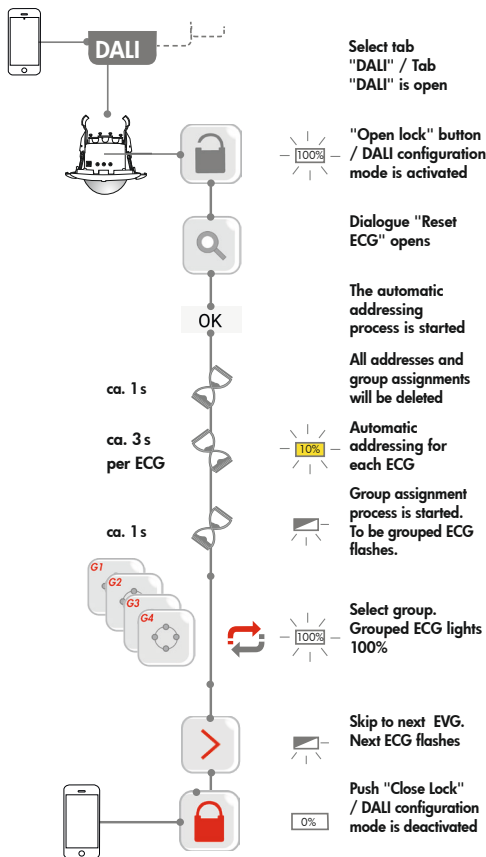

12.3 Step 3: Check grouping and amend if necessary

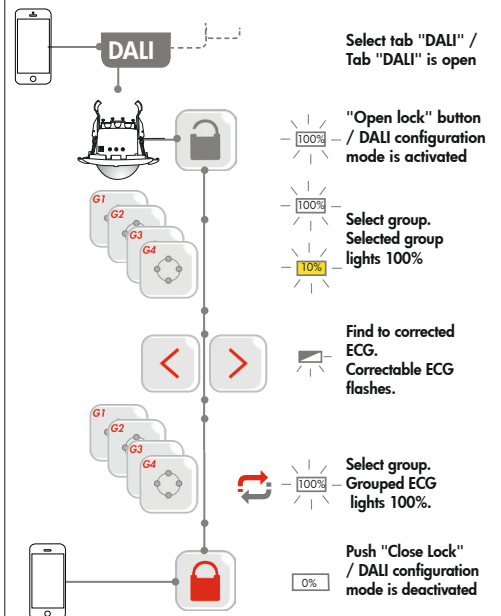

13. Adding or replacing electronic ballasts

For cases where individual DALI electronic ballasts are to be replaced, or others added, there is a DALI maintenance mode. In DALI maintenance mode, only DALI electronic ballasts with a short address of "FF" have their addresses reset and released for grouping. This short address is saved as a factory setting on all new DALI electronic ballasts. Therefore DALI maintenance mode does not work with DALI electronic ballasts which have already been addressed in another DALI system (value not "FF").

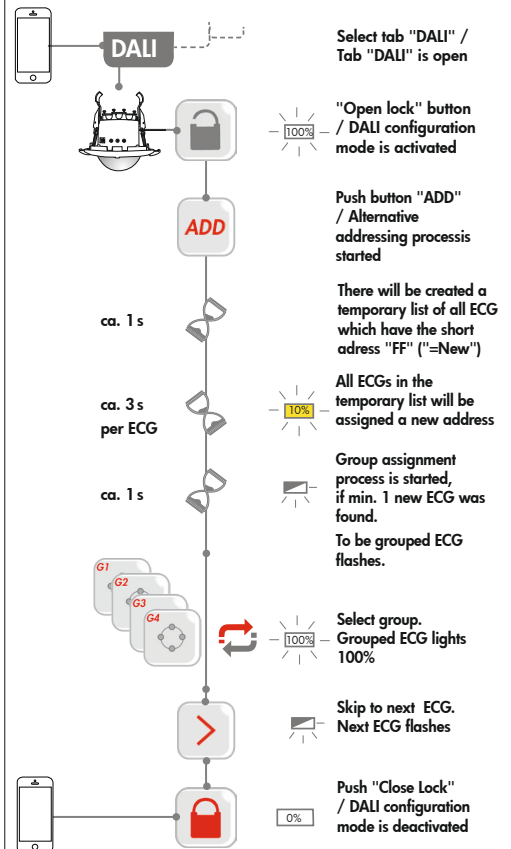

14. Set Lux setpoint

14.1 Alignment

Always align the light sensor towards a lighting area belonging to Group 1. For this, the sensor can be angled vertically at 30° from the floor towards the wall.

14.2 Default settings

Use presets over the LUX parameters (App or potentiometer), to get faster results.

14.3 Process description

Step 1: Darken the room. There should be only light available, which can be implemented via the device connected to the detector lighting system.

Step 2: Place a calibrated light meter in the field of group 1

Step 3: Use the manual dimming and eyes button in the smartphone app in the tab „command“, to store the desired setpoint LUX. It may take up to 2 minutes, until the new adjustment shows effect.

Step 4: Use the + / - buttons in the smartphone app for minimal corrections

15. Article / Part nr. / Accessory

Typ	Part.-Nr.
PD4-M-DAA4G-FC	92591
PD4-M-DAA4G-SM	92743
IR-Adapter	92726
Accessory (optional)	
PD4-S-DAA4G-FC	92721
PD4-S-DAA4G-SM	92759

16. Technical data

Power supply:	110-240 V AC , 50 / 60 Hz
Area of coverage:	circular, 360°
Range of coverage:	Ø 24 m transverse
Range of coverage:	Ø 8 m towards
Range of coverage:	Ø 6,4 m seated
Protection type/class:	IP20 / II / CE
Ambient temperature:	-25°C / +50°C
Dimensions:	PD4-M-DAA4G-FC Ø 117 x 100 mm
Mounting-hole FC:	Ø 100 mm
	PD4-S-DAA4G-SM Ø 124 x H 85 mm
Case:	Polycarbonate, UV-resistant
Remote control:	Smartphone app and IR-Adapter
DALI Control:	
DALI:	1-64 DALI-EVG, Max. 150 mA
Follow-up time:	1 to 150 Min. (Lighting zones)
Light sensor:	100 to 1000 Lux
	Relay (potential-free, NO):
Relay:	2300 W, cosφ = 1; 1150 VA, cosφ = 0,5, µ-microcontact
Follow-up time:	5 to 120 Min. (HVAC)

CE Declaration of conformity

This product respects the directives concerning

1. electromagnetic compatibility (2004/108/EU)
2. low voltage (2006/95/EU)
3. restriction of the use of certain hazardous substances in electrical and electronic equipment (2011/65/EU)

17. Potential problems

There can be many causes of problems with lighting control. The following shows a selection of possible causes.

DALI message conflict due to duplicate addresses

If electronic ballasts are added which have been changed from factory settings, or have been addressed already in another system, there is a risk that the same address could be duplicated. Inevitably, this leads to DALI protocol conflicts, which results in unpredictable lighting control behaviour. Remedy: In carrying out maintenance, only use electronic ballasts in factory condition for exchange or expansion. If you are not able to use factory-condition electronic ballasts, you will have to follow the "Set up addresses" use case. This use case resets all electronic ballasts to factory settings before setting up addresses.

Current draw of connected DALI units too high

If DALI units use too much current, this can lead to errors. In designing your system, please take into account the total current draw of all DALI units (electronic ballasts and any slave devices). The integrated DALI power supply can provide a stable supply voltage when total current draw of all DALI units is 150 mA.

Light switches on automatically although darkness is required (e.g. for a training presentation)

This lighting behaviour occurs if, in full automatic mode, no movement is detected after operation of the push button within the follow-up time that has been set. Thus, if people in the room are very still during the presentation, it can lead to this undesirable effect. Measures to alleviate this can include increasing the sensitivity of the motion sensor, installing slave devices and/or increasing the follow-up time. As a last resort, only semi-automatic mode can reliably eliminate the problem.

B.E.G. LUXOMAT® PD4-M-DAA4G



Figures PD4-M-DAA4G-SM/FC

3.1.

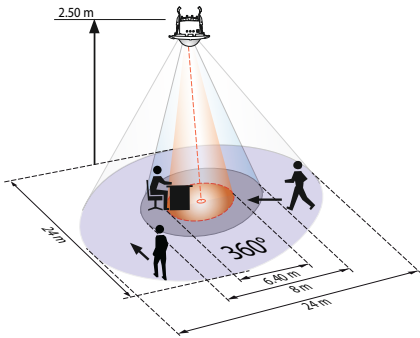

- walking towards
- walking across
- seated

3.2.

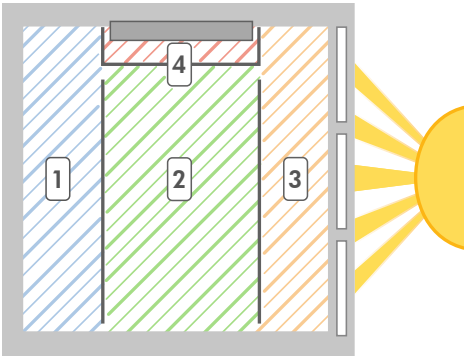

3.3.

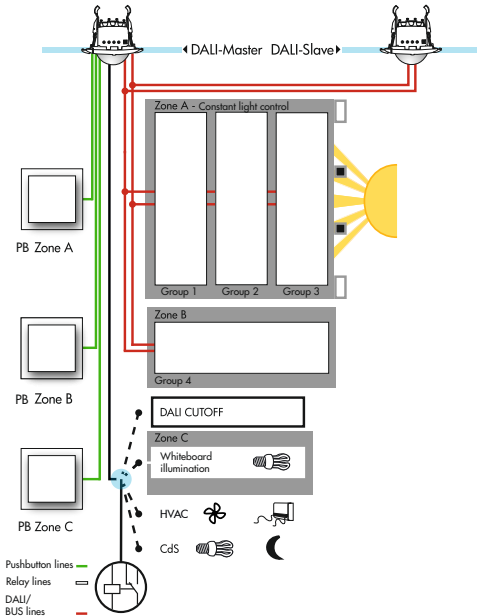

3.6.



4.

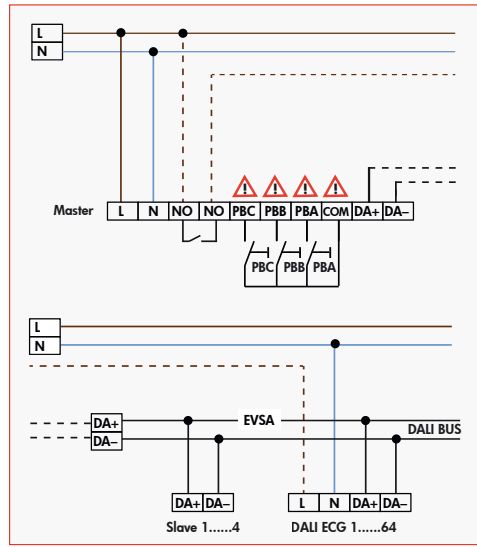

4.3.1

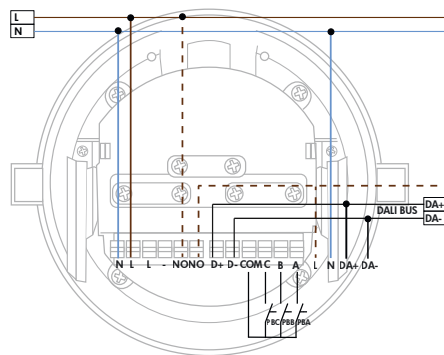

4.3.2

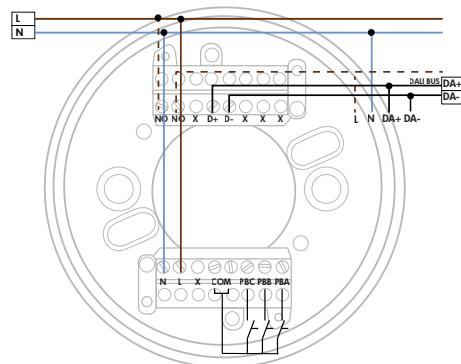

5.2.

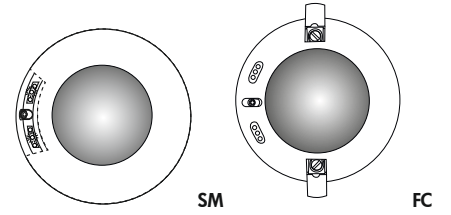

5.3.

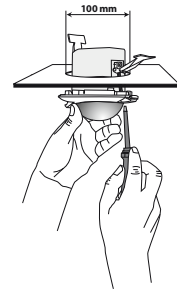

5.4.

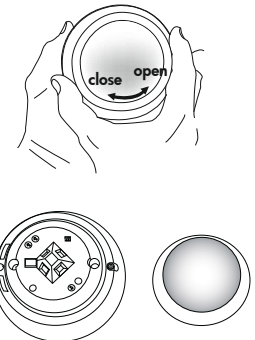

8.

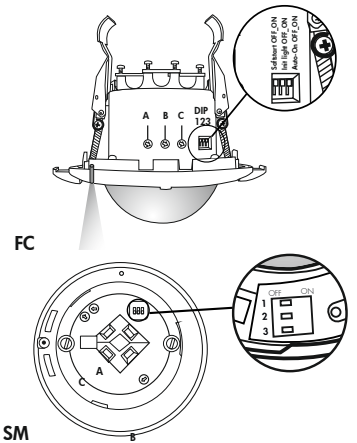

9.

