

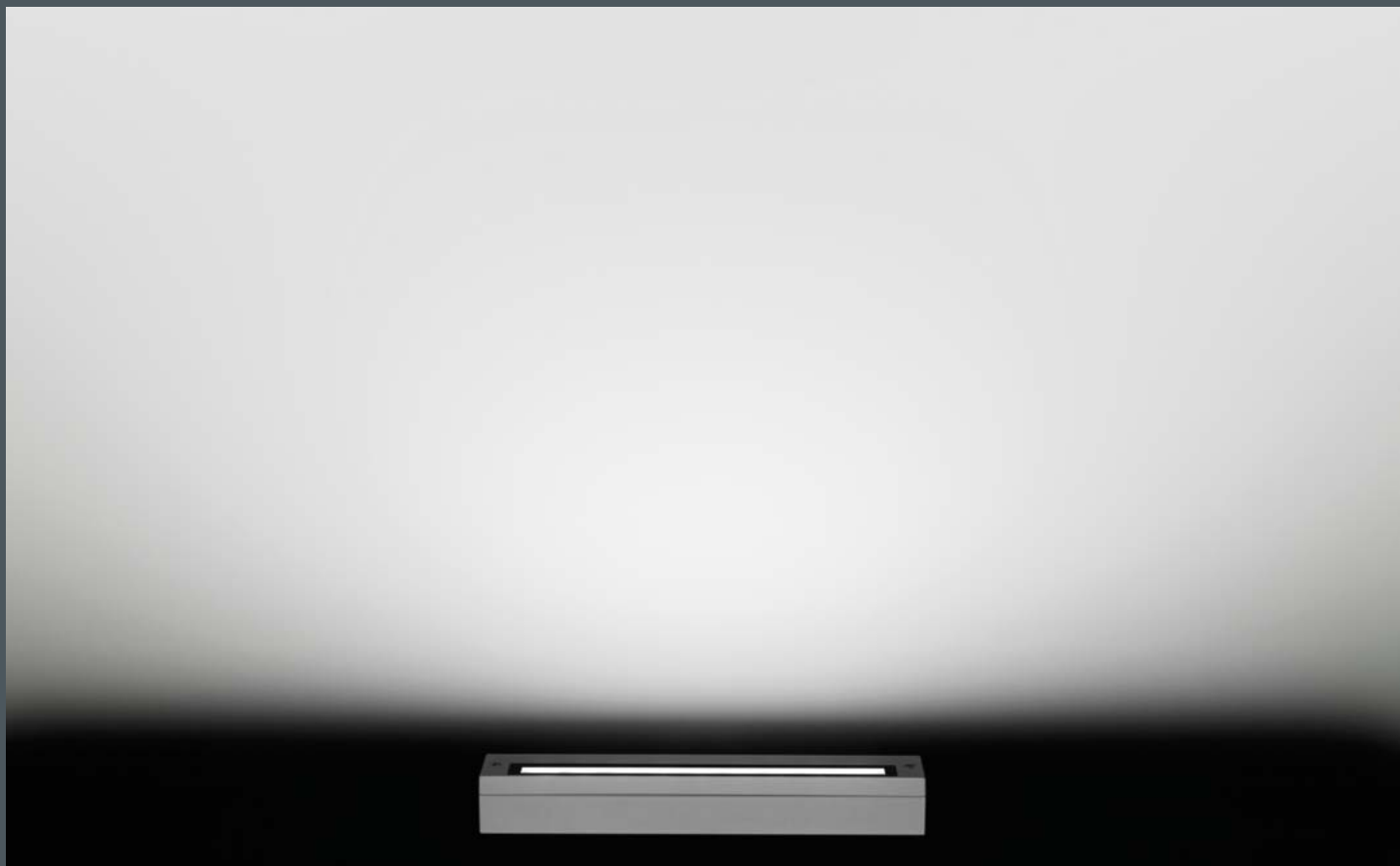

New Products 2018



Highline is a range of façade luminaires of minimalistic design. They are available with wall washer, narrow beam or asymmetrical distribution. The fields of application range from accent lighting to uniform wall washing. Highline is a versatile instrument for many different applications, in a uniform and discreet housing.



With narrow beam distribution the luminaires are used for the accent lighting of vertical surfaces.



The narrow beam version produces an intensive grazing effect above the longitudinal axis of the luminaire.

The luminaires are available with 3 different fixing systems:
a bracket for installation on a façade, a mounting base or a wall arm.

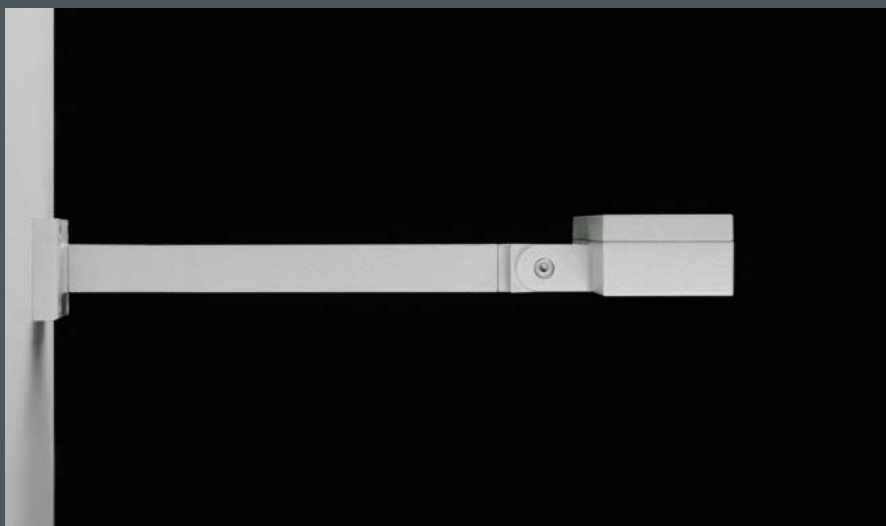

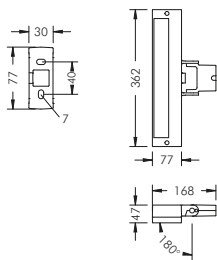

Highline with wall bracket

With high performance LEDs, integral temperature monitoring device, CRI: > 80, Colour tolerance: max. 2 SDCM Service life: L90/B10 > 50 000 h protection class I, IP65 IK08 windage area AW 0.029 m² corrosion-resistant die cast aluminium housing AlSi12, polyester powder coated, all exterior steel parts are stainless steel, tempered safety glass, silicon gasket, closure with 2 stainless steel screws, wall bracket: 2 elongated holes Ø 6,5 mm, spacing 40 mm, tilt range 180°, M20 cable gland, integral driver (AC/DC)

Highline, narrow beam

Part number	Colour	Light source	Luminous flux	Beam angle γ (FWHM)
8 730 146 019	black	9 x LED 2.5 W warm white (3000 K)	1508 lm	6°
8 730 166 019	white			
8 730 156 019	silver grey			

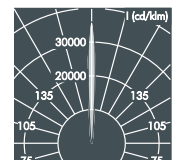
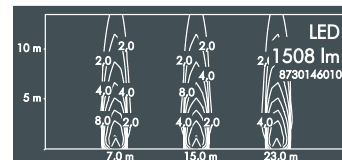

Part number	Colour	Light source	Luminous flux	Beam angle γ (FWHM)
8 730 145 019	black	9 x LED 2.5 W neutral white (4000 K)	1583 lm	6°
8 730 165 019	white			
8 730 155 019	silver grey			

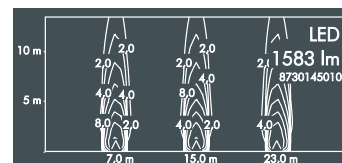

Highline, wall washer

Part number	Colour	Light source	Luminous flux	Beam angle γ (FWHM)
8 730 146 009	black	9 x LED 2.5 W warm white (3000 K)	1281 lm	C 0 - 180 C 90 - 270
8 730 166 009	white			
8 730 156 009	silver grey			

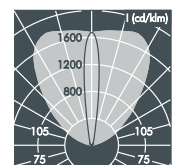
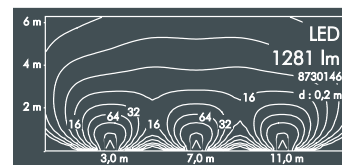

Part number	Colour	Light source	Luminous flux	Beam angle γ (FWHM)
8 730 145 009	black	9 x LED 2.5 W neutral white (4000 K)	1345 lm	C 0 - 180 C 90 - 270
8 730 165 009	white			
8 730 155 009	silver grey			

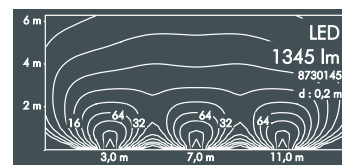

Highline, asymmetrical beam

Part number	Colour	Light source	Luminous flux	Main beam angle γ
8 730 146 089	black	9 x LED 2.5 W warm white (3000 K)	1121 lm	35°
8 730 166 089	white			
8 730 156 089	silver grey			

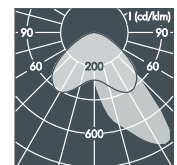
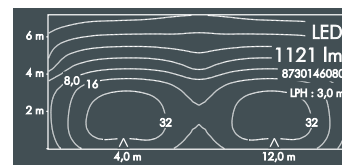

Part number	Colour	Light source	Luminous flux	Main beam angle γ
8 730 145 089	black	9 x LED 2.5 W neutral white (4000 K)	1177 lm	35°
8 730 165 089	white			
8 730 155 089	silver grey			

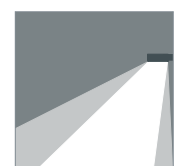
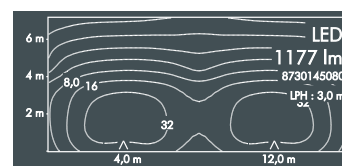

Part number	Description
. . . . 0	Luminaire with mounting flange (for horizontal surfaces)

Part number	Description
. 1 . .	Dimmable luminaire (DALI)
. 2 . .	Dimmable luminaire (1-10 V)

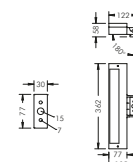

LED

Luminaires available in 2700 K and other colour temperatures on request

Highline with wall arm

With high performance LEDs,
 integral temperature monitoring device,
 CRI: > 80, Colour tolerance: max. 2 SDCM
 Service life: L90/B10 > 50 000 h
 protection class I, IP65 , IK08
 windage area AW 0.035 m²
 corrosion-resistant die cast aluminium housing AlSi12,
 polyester powder coated,
 all exterior steel parts are stainless steel,
 tempered safety glass,
 silicon gasket, closure with 2 stainless steel screws,
 mounting plate: 4 drilled holes Ø 7 mm,
 spacing 47 mm, joint with tilt range 180°,
 M20 cable gland,
 integral driver (AC/DC)

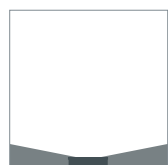
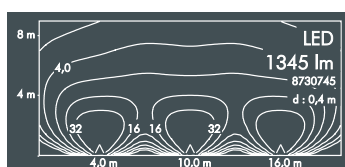
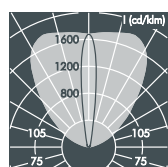
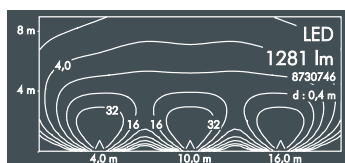
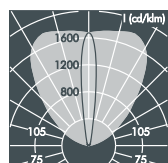
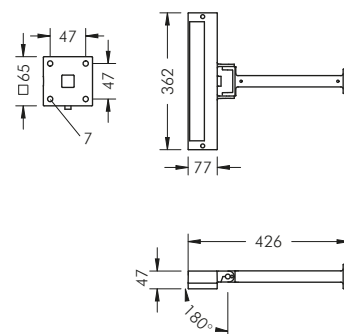

Highline with wall arm, wall washer

Part number	Colour	Light source	Luminous flux	Beam angle γ (FWHM)	
8 730 746 009	black	9 x LED 2.5 W warm white (3000 K)	1281 lm	C 0 – 180	C 90 – 270
8 730 766 009	white			14°	93°
8 730 756 009	silver grey				

Part number	Colour	Light source	Luminous flux	Beam angle γ (FWHM)	
8 730 745 009	black	9 x LED 2.5 W neutral white (4000 K)	1345 lm	C 0 – 180	C 90 – 270
8 730 765 009	white			14°	93°
8 730 755 009	silver grey				

Part number	Description
• • • • • 1 ..	Dimmable luminaire (DALI)
• • • • • 2 ..	Dimmable luminaire (1-10 V)

LED

Luminaires available in 2700 K and other colour temperatures on request



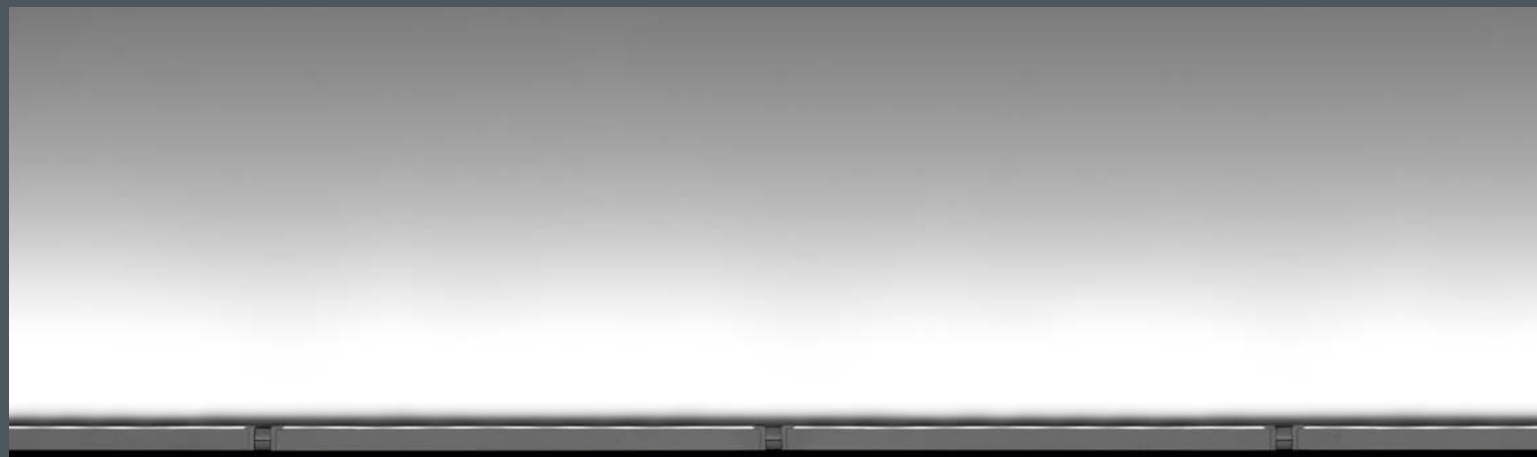

Ecoline Mini is a façade luminaire series of extremely compact dimensions and with integral driver. As well as individual luminaires there is also a modular system available for creating continuous lines with barely any shadow between the sections. The very slim cross section allows for discreet installation. The luminaires are available with wall washer optics or in asymmetrical distribution.

Ecoline Mini complements the Ecoline series with products of even more compact dimensions. They are the smallest linear products on the market with integral driver, for direct connection to mains voltage.

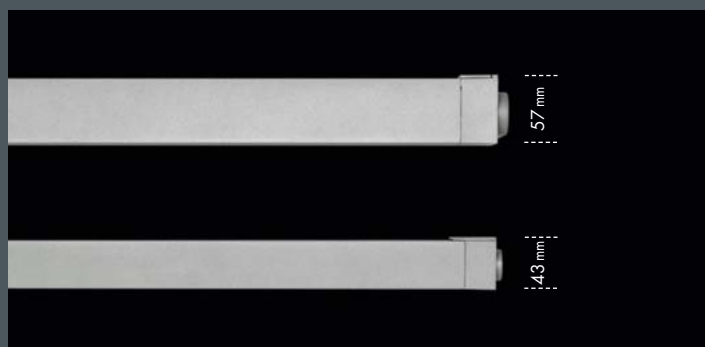

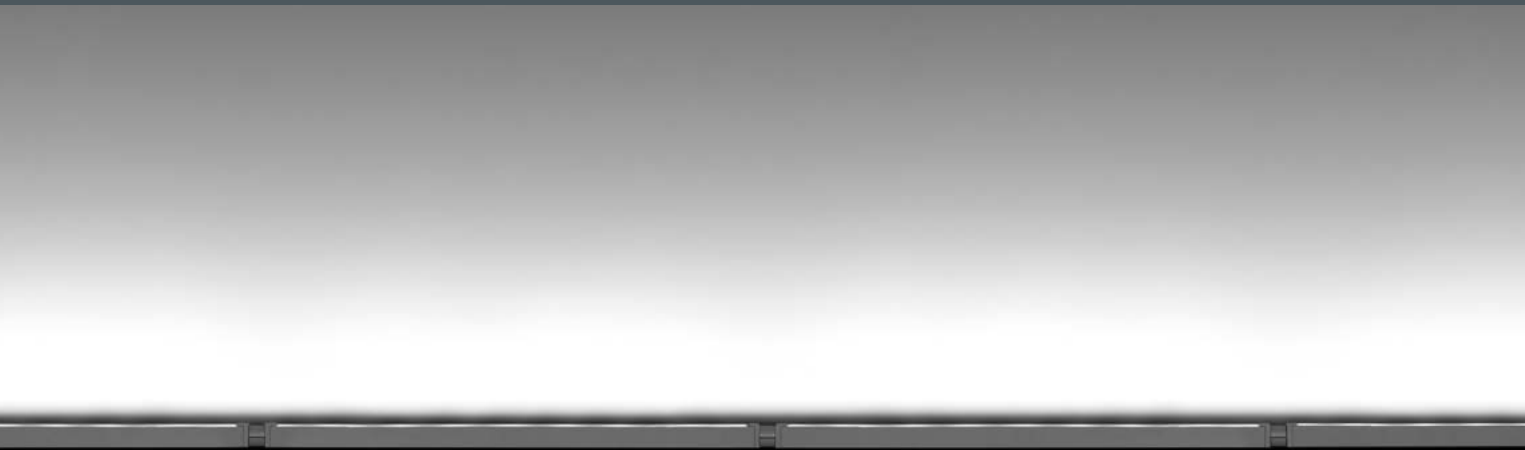

Design: Roy Fleetwood



The precise optics produce wall washer or asymmetrical distribution.

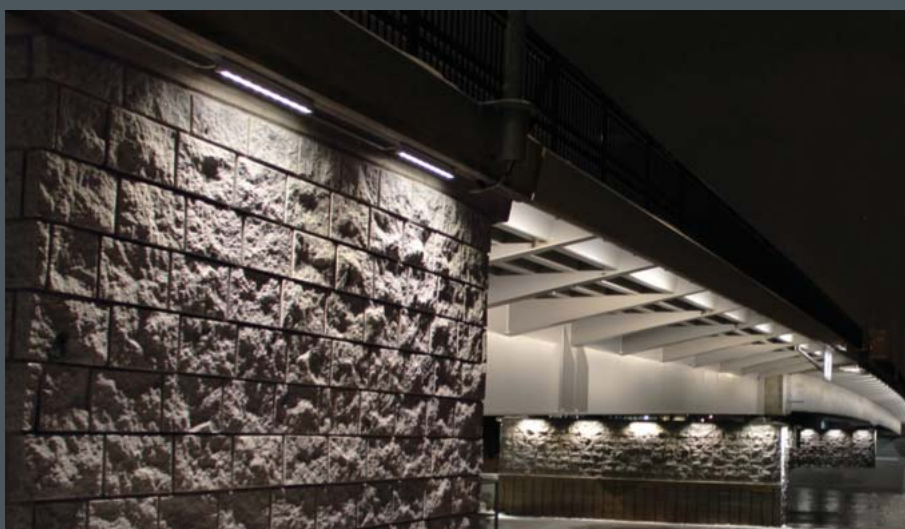

Sirkkalan Silta, Finland
Lighting design: Ramboll, Satu Marttila

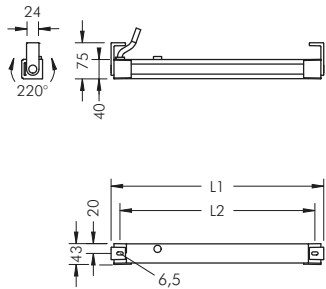

Ecoline Mini

With high performance LEDs, integral temperature monitoring device, CRI: > 80, Colour tolerance: max. 2 SDCM Service life: L90/B10 > 50 000 h protection class I, IP65 \diamond \triangle \triangle , IK10 housing made of extruded aluminium and corrosion-resistant die cast aluminium AlSi12, polyester powder coated, all exterior steel parts are stainless steel, polycarbonate cover, silicon gasket, mounting flanges: 2 elongated holes \varnothing 6.5 mm, spacing L2, tilt range 220°, M16 cable gland with 1 m cable H05RN-F3G1 attached, integral driver (AC/DC)

Ecoline Mini, wall washer, L1 = 444 mm, L2 = 407 mm

Part number	Colour	Light source	Luminous flux	Beam angle γ (FWHM)	
				C 0 - 180	C 90 - 270
8 766 946 009	black	3 x LED 1.7 W warm white (3000 K)	293 lm	20°	88°
8 766 966 009	white				
8 766 956 009	silver grey				

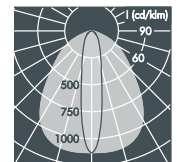
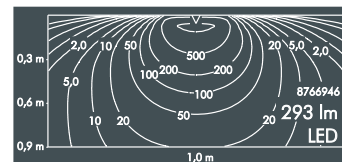

Part number	Colour	Light source	Luminous flux	Beam angle γ (FWHM)	
				C 0 - 180	C 90 - 270
8 766 945 009	black	3 x LED 1.7 W neutral white (4000 K)	308 lm	20°	88°
8 766 965 009	white				
8 766 955 009	silver grey				

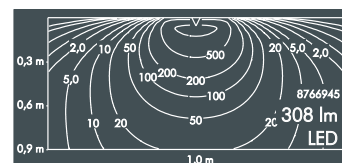

Ecoline Mini, wall washer, L1 = 668 mm, L2 = 631 mm

Part number	Colour	Light source	Luminous flux	Beam angle γ (FWHM)	
				C 0 - 180	C 90 - 270
8 766 046 009	black	6 x LED 1.7 W warm white (3000 K)	585 lm	20°	88°
8 766 066 009	white				
8 766 056 009	silver grey				

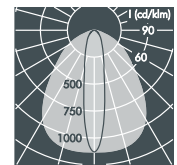
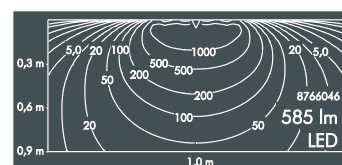

Part number	Colour	Light source	Luminous flux	Beam angle γ (FWHM)	
				C 0 - 180	C 90 - 270
8 766 045 009	black	6 x LED 1.7 W neutral white (4000 K)	614 lm	20°	88°
8 766 065 009	white				
8 766 055 009	silver grey				

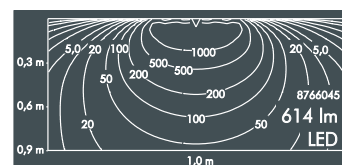

Ecoline Mini, wall washer, L1 = 962 mm, L2 = 925 mm

Part number	Colour	Light source	Luminous flux	Beam angle γ (FWHM)	
				C 0 - 180	C 90 - 270
8 766 146 009	black	9 x LED 1.7 W warm white (3000 K)	878 lm	20°	88°
8 766 166 009	white				
8 766 156 009	silver grey				

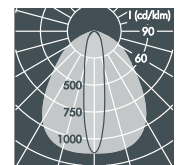
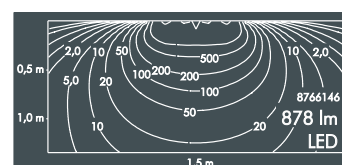

Part number	Colour	Light source	Luminous flux	Beam angle γ (FWHM)	
				C 0 - 180	C 90 - 270
8 766 145 009	black	9 x LED 1.7 W neutral white (4000 K)	922 lm	20°	88°
8 766 165 009	white				
8 766 155 009	silver grey				

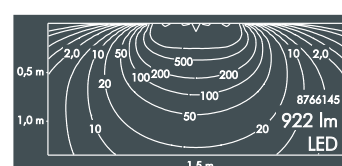

Part number	Description
. 1..	Dimmable luminaire (DALI)*
. 2..	Dimmable luminaire (1-10 V)*

* Not available for luminaire L1 = 444 mm

LED

Luminaires available in 2700 K and other colour temperatures on request

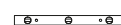

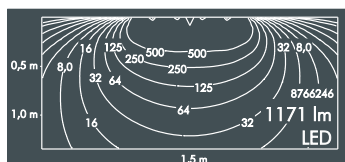
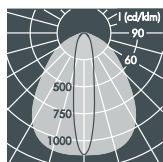

Ecoline Mini, wall washer, L1 = 1256 mm, L2 = 1219 mm

Part number	Colour	Light source	Luminous flux	Beam angle γ (FWHM)	
				C 0 – 180	C 90 – 270
8 766 246 009	black	12 x LED 1.7 W warm white (3000 K)	1171 lm	20°	88°
8 766 266 009	white				
8 766 256 009	silver grey				

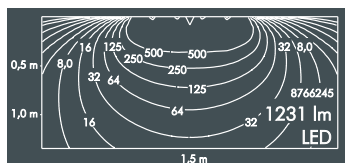

Part number	Colour	Light source	Luminous flux	Beam angle γ (FWHM)	
				C 0 – 180	C 90 – 270
8 766 245 009	black	12 x LED 1.7 W neutral white (4000 K)	1231 lm	20°	88°
8 766 265 009	white				
8 766 255 009	silver grey				

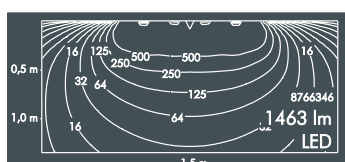
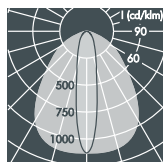

Ecoline Mini, wall washer, L1 = 1550 mm, L2 = 1513 mm

Part number	Colour	Light source	Luminous flux	Beam angle γ (FWHM)	
				C 0 – 180	C 90 – 270
8 766 346 009	black	15 x LED 1.7 W warm white (3000 K)	1463 lm	20°	88°
8 766 366 009	white				
8 766 356 009	silver grey				

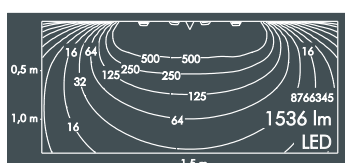

Part number	Colour	Light source	Luminous flux	Beam angle γ (FWHM)	
				C 0 – 180	C 90 – 270
8 766 345 009	black	15 x LED 1.7 W neutral white (4000 K)	1536 lm	20°	88°
8 766 365 009	white				
8 766 355 009	silver grey				



Ecoline Mini, asymmetrical beam**

Part number	Description
. 8.	Luminaires with asymmetrical distribution

** The luminaires are available in 5 different lengths.

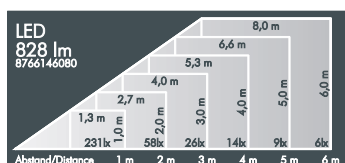
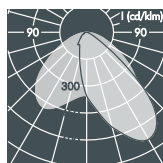

Ecoline Mini, asymmetrical beam, L1 = 962 mm, L2 = 925 mm

Part number	Colour	Light source	Luminous flux	Main beam angle γ
8 766 146 089	black	9 x LED 1.7 W warm white (3000 K)	828 lm	30°
8 766 166 089	white			
8 766 156 089	silver grey			

Part number	Description
. 1..	Dimmable luminaire (DALI)*
. 2..	Dimmable luminaire (1-10 V)*

* Not available for luminaire L1 = 444 mm

LED

Luminaires available in 2700 K and other colour temperatures on request

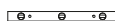

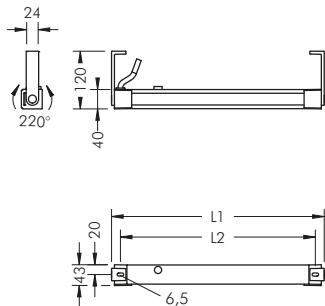

Ecoline Mini with wall arms

With high performance LEDs, integral temperature monitoring device, CRI: > 80, Colour tolerance: max. 2 SDCM Service life: L90/B10 > 50 000 h protection class I, IP65 , IK10 housing made of extruded aluminium and corrosion-resistant die cast aluminium AlSi12, polyester powder coated, all exterior steel parts are stainless steel, polycarbonate cover, silicon gasket, wall arms: 2 elongated holes Ø 6.5 mm, spacing L2, tilt range 220°, M16 cable gland with 1 m cable H05RN-F3G1 attached, integral driver (AC/DC)

Ecoline Mini, wall washer with wall arms, L1 = 444 mm, L2 = 407 mm

Part number	Colour	Light source	Luminous flux	Beam angle γ (FWHM)	
				C 0 – 180	C 90 – 270
8 767 946 009	black	3 x LED 1.7 W warm white (3000 K)	293 lm	20°	88°
8 767 966 009	white				
8 767 956 009	silver grey				

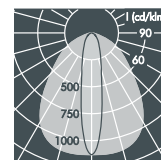
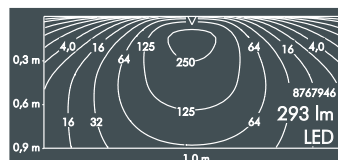

Part number	Colour	Light source	Luminous flux	Beam angle γ (FWHM)	
				C 0 – 180	C 90 – 270
8 767 945 009	black	3 x LED 1.7 W neutral white (4000 K)	308 lm	20°	88°
8 767 965 009	white				
8 767 955 009	silver grey				

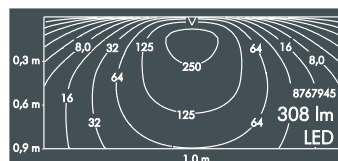

Ecoline Mini, wall washer with wall arms, L1 = 668 mm, L2 = 631 mm

Part number	Colour	Light source	Luminous flux	Beam angle γ (FWHM)	
				C 0 – 180	C 90 – 270
8 767 046 009	black	6 x LED 1.7 W warm white (3000 K)	585 lm	20°	88°
8 767 066 009	white				
8 767 056 009	silver grey				

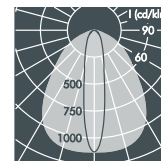
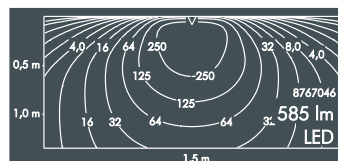

Part number	Colour	Light source	Luminous flux	Beam angle γ (FWHM)	
				C 0 – 180	C 90 – 270
8 767 045 009	black	6 x LED 1.7 W neutral white (4000 K)	614 lm	20°	88°
8 767 065 009	white				
8 767 055 009	silver grey				

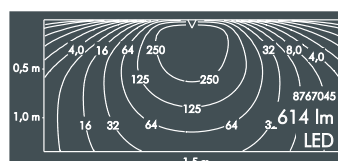

Ecoline Mini, wall washer with wall arms, L1 = 962 mm, L2 = 925 mm

Part number	Colour	Light source	Luminous flux	Beam angle γ (FWHM)	
				C 0 – 180	C 90 – 270
8 767 146 009	black	9 x LED 1.7 W warm white (3000 K)	878 lm	20°	88°
8 767 166 009	white				
8 767 156 009	silver grey				

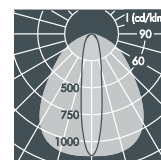
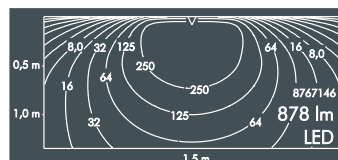

Part number	Colour	Light source	Luminous flux	Beam angle γ (FWHM)	
				C 0 – 180	C 90 – 270
8 767 145 009	black	9 x LED 1.7 W neutral white (4000 K)	922 lm	20°	88°
8 767 165 009	white				
8 767 155 009	silver grey				

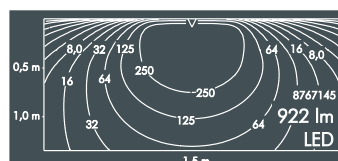

Part number	Description
. 1..	Dimmable luminaire (DALI)*
. 2..	Dimmable luminaire (1-10 V)*

* Not available for luminaire L1 = 444 mm

LED

Luminaires available in 2700 K and other colour temperatures on request

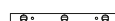

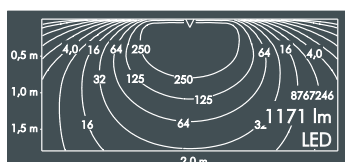
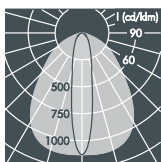

Ecoline Mini, wall washer with wall arms, L1 = 1256 mm, L2 = 1219 mm

Part number	Colour	Light source	Luminous flux	Beam angle γ (FWHM)	
				C 0 – 180	C 90 – 270
8 767 246 009	black	12 x LED 1.7 W warm white (3000 K)	1171 lm	20°	88°
8 767 266 009	white				
8 767 256 009	silver grey				

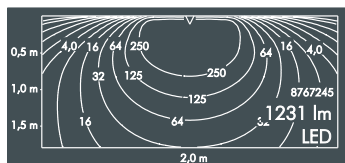

Part number	Colour	Light source	Luminous flux	Beam angle γ (FWHM)	
				C 0 – 180	C 90 – 270
8 767 245 009	black	12 x LED 1.7 W neutral white (4000 K)	1231 lm	20°	88°
8 767 265 009	white				
8 767 255 009	silver grey				

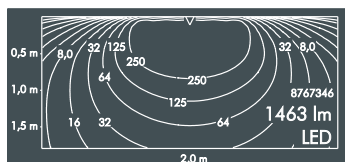
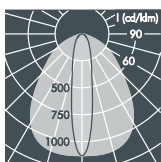

Ecoline Mini, wall washer with wall arms, L1 = 1550 mm, L2 = 1513 mm

Part number	Colour	Light source	Luminous flux	Beam angle γ (FWHM)	
				C 0 – 180	C 90 – 270
8 767 346 009	black	15 x LED 1.7 W warm white (3000 K)	1463 lm	20°	88°
8 767 366 009	white				
8 767 356 009	silver grey				

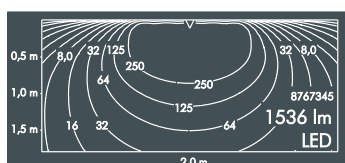

Part number	Colour	Light source	Luminous flux	Beam angle γ (FWHM)	
				C 0 – 180	C 90 – 270
8 767 345 009	black	15 x LED 1.7 W neutral white (4000 K)	1536 lm	20°	88°
8 767 365 009	white				
8 767 355 009	silver grey				

Part number	Description
. 1 . .	Dimmable luminaire (DALI)*
. 2 . .	Dimmable luminaire (1-10 V)*

* Not available for luminaire L1 = 444 mm

LED

Luminaires available in 2700 K and other colour temperatures on request

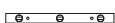

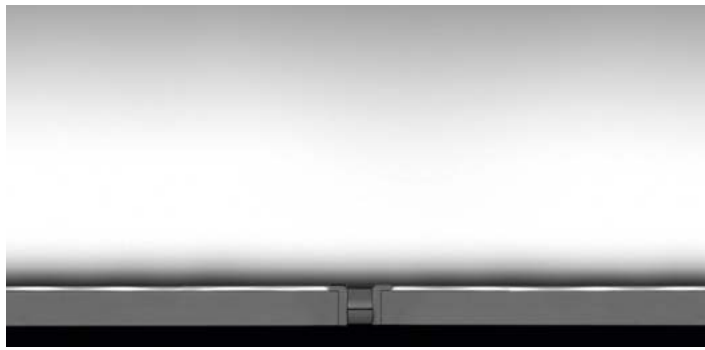

Ecoline Mini S Modular System

The luminaire modules are joined together in continuous runs. The luminaire system is installed using either wall flanges or wall arms. The wall arms increase the distance between the luminaire and the surface to be illuminated, thus increasing the uniformity of light distribution.

Regardless of the number of luminaires to be connected, just 1 wall flange set **or** 1 wall arm set is required to mount the outer left and right hand luminaires, SL and SR, to the surface.

Mounting components for Ecoline Mini S Modular System

Part number	Colour	Description
127 0 392 940	black	Wall flange set, (pair) for outer luminaires
127 0 392 960	white	
127 0 392 950	silver grey	

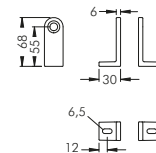

Mounting components for Ecoline Mini S Modular System

Part number	Colour	Description
127 0 393 940	black	Wall arm set, (pair) for outer luminaires, length 100 mm
127 0 393 960	white	
127 0 393 950	silver grey	

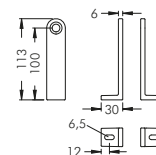

To connect two luminaires together, either one connection flange **or** one connection arm is required. The number of these connection parts required equals the total number of luminaires minus 1.

Mounting components for Ecoline Mini S Modular System

Part number	Colour	Description
127 0 390 940	black	Connection flange, to connect two luminaires
127 0 390 960	white	
127 0 390 950	silver grey	

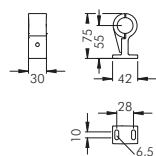

Mounting components for Ecoline Mini S Modular System

Part number	Colour	Description
127 0 391 940	black	Connection arm, to connect two luminaires, length 100 mm
127 0 391 960	white	
127 0 391 950	silver grey	

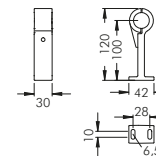

The Modular System

Luminaires of different lengths and wattages can be connected together. One left (SL) and one right (SR) luminaire are always required. In addition to these, middle luminaires (SM) can be added to the system.

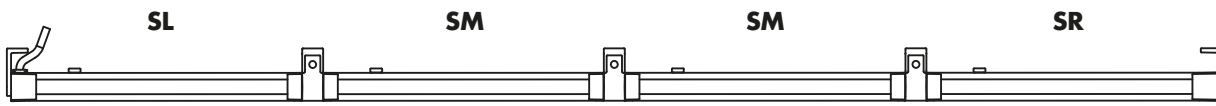
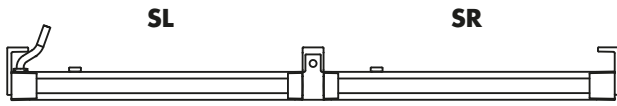

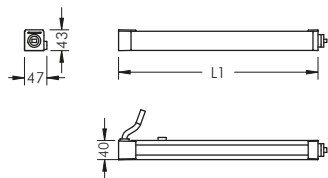

Ecoline Mini SL Modular System, left

With high performance LEDs, integral temperature monitoring device, CRI: > 80, Colour tolerance: max. 2 SDCM
Service life: L90/B10 > 50 000 h
protection class I, IP65 ⚡⚡⚡, IK10
housing made of extruded aluminium and corrosion-resistant die cast aluminium AlSi12, polyester powder coated, all exterior steel parts are stainless steel, polycarbonate cover, silicon gasket, with connection coupling and 3-pin connector on right, tilt range 220°, M16 cable gland with 1 m cable H05RN-F3G1 attached, integral driver (AC/DC)

Ecoline Mini SL, left, wall washer, L1 = 641 mm

Part number	Colour	Light source	Luminous flux	Beam angle γ (FWHM)	
				C 0 - 180	C 90 - 270
8 768 046 009	black	6 x LED 1.7 W warm white (3000 K)	585 lm	20°	88°
8 768 066 009	white				
8 768 056 009	silver grey				

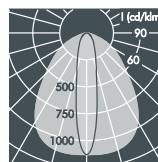

Ecoline Mini SL, left, wall washer, L1 = 935 mm

Part number	Colour	Light source	Luminous flux	Beam angle γ (FWHM)	
				C 0 - 180	C 90 - 270
8 768 146 009	black	9 x LED 1.7 W warm white (3000 K)	878 lm	20°	88°
8 768 166 009	white				
8 768 156 009	silver grey				

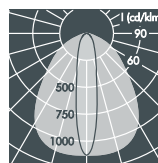

Ecoline Mini SL, left, wall washer, L1 = 1229 mm

Part number	Colour	Light source	Luminous flux	Beam angle γ (FWHM)	
				C 0 - 180	C 90 - 270
8 768 246 009	black	12 x LED 1.7 W warm white (3000 K)	1171 lm	20°	88°
8 768 266 009	white				
8 768 256 009	silver grey				

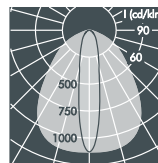

Ecoline Mini SL, left, wall washer, L1 = 1523 mm

Part number	Colour	Light source	Luminous flux	Beam angle γ (FWHM)	
				C 0 - 180	C 90 - 270
8 768 346 009	black	15 x LED 1.7 W warm white (3000 K)	1463 lm	20°	88°
8 768 366 009	white				
8 768 356 009	silver grey				

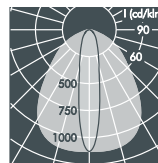

Ecoline Mini SL, left, wall washer

Part number	Description
. 5 . . .	Luminaire with neutral white colour temperature (4000 K)
. 1 . .	Dimmable luminaire (DALI)
. 2 . .	Dimmable luminaire (1-10 V)

The luminaires can be supplied with asymmetrical light distribution upon request.

LED

Luminaires available in 2700 K and other colour temperatures on request

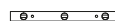

Ecoline Mini SM Modular System, middle

With high performance LEDs,
integral temperature monitoring device,
CRI: > 80, Colour tolerance: max. 2 SDCM
Service life: L90/B10 > 50 000 h
protection class I, IP65 , IK10
housing made of extruded aluminium and
corrosion-resistant die cast aluminium AlSi12,
polyester powder coated,
all exterior steel parts are stainless steel,
polycarbonate cover, silicon gasket,
with connection coupling and
3-pin connector on left and right,
tilt range 220°,
integral driver (AC/DC)

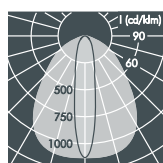
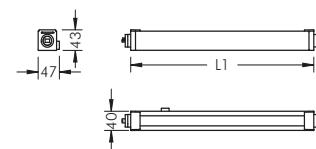

Ecoline Mini SM, middle, wall washer, L1 = 625 mm

Part number	Colour	Light source	Luminous flux	Beam angle γ (FWHM)	
8 769 046 009	black	6 x LED 1.7 W warm white (3000 K)	585 lm	C 0 – 180	C 90 – 270
8 769 066 009	white			20°	88°
8 769 056 009	silver grey				

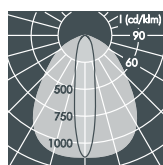

Ecoline Mini SM, middle, wall washer, L1 = 919 mm

Part number	Colour	Light source	Luminous flux	Beam angle γ (FWHM)	
8 769 146 009	black	9 x LED 1.7 W warm white (3000 K)	878 lm	C 0 – 180	C 90 – 270
8 769 166 009	white			20°	88°
8 769 156 009	silver grey				

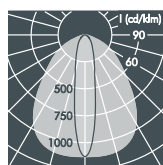

Ecoline Mini SM, middle, wall washer, L1 = 1213 mm

Part number	Colour	Light source	Luminous flux	Beam angle γ (FWHM)	
8 769 246 009	black	12 x LED 1.7 W warm white (3000 K)	1171 lm	C 0 – 180	C 90 – 270
8 769 266 009	white			20°	88°
8 769 256 009	silver grey				

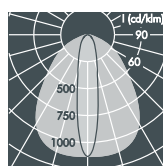

Ecoline Mini SM, middle, wall washer, L1 = 1507 mm

Part number	Colour	Light source	Luminous flux	Beam angle γ (FWHM)	
8 769 346 009	black	15 x LED 1.7 W warm white (3000 K)	1463 lm	C 0 – 180	C 90 – 270
8 769 366 009	white			20°	88°
8 769 356 009	silver grey				

Ecoline Mini SM, middle, wall washer

Part number	Description
. 5 . . .	Luminaire with neutral white colour temperature (4000 K)
. 1 . .	Dimmable luminaire (DALI)
. 2 . .	Dimmable luminaire (1-10 V)

The luminaires can be supplied with asymmetrical light distribution upon request.

LED

Luminaires available in 2700 K and other colour temperatures on request

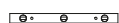

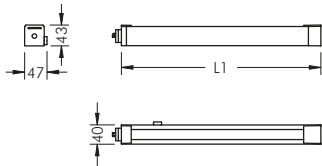

Ecoline Mini SR Modular System, right

With high performance LEDs, integral temperature monitoring device, CRI: > 80, Colour tolerance: max. 2 SDCM
Service life: L90/B10 > 50 000 h
protection class I, IP65 , IK10
housing made of extruded aluminium and corrosion-resistant die cast aluminium AlSi12, polyester powder coated, all exterior steel parts are stainless steel, polycarbonate cover, silicon gasket, with connection coupling and 3-pin connector on left, tilt range 220°, integral driver (AC/DC)

Ecoline Mini SR, right, wall washer, L1 = 641 mm

Part number	Colour	Light source	Luminous flux	Beam angle γ (FWHM)	
				C 0 - 180	C 90 - 270
8 770 046 009	black	6 x LED 1.7 W warm white (3000 K)	585 lm	20°	88°
8 770 066 009	white				
8 770 056 009	silver grey				

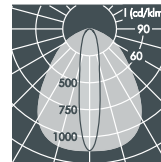

Ecoline Mini SR, right, wall washer, L1 = 935 mm

Part number	Colour	Light source	Luminous flux	Beam angle γ (FWHM)	
				C 0 - 180	C 90 - 270
8 770 146 009	black	9 x LED 1.7 W warm white (3000 K)	878 lm	20°	88°
8 770 166 009	white				
8 770 156 009	silver grey				

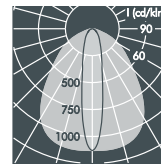

Ecoline Mini SR, right, wall washer, L1 = 1229 mm

Part number	Colour	Light source	Luminous flux	Beam angle γ (FWHM)	
				C 0 - 180	C 90 - 270
8 770 246 009	black	12 x LED 1.7 W warm white (3000 K)	1171 lm	20°	88°
8 770 266 009	white				
8 770 256 009	silver grey				

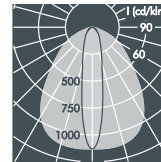

Ecoline Mini SR, right, wall washer, L1 = 1523 mm

Part number	Colour	Light source	Luminous flux	Beam angle γ (FWHM)	
				C 0 - 180	C 90 - 270
8 770 346 009	black	15 x LED 1.7 W warm white (3000 K)	1463 lm	20°	88°
8 770 366 009	white				
8 770 356 009	silver grey				

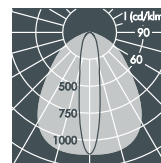

Ecoline Mini SR, right, wall washer

Part number	Description
. 5 . . .	Luminaire with neutral white colour temperature (4000 K)
. 1 . .	Dimmable luminaire (DALI)
. 2 . .	Dimmable luminaire (1-10 V)

The luminaires can be supplied with asymmetrical light distribution upon request.

LED

Luminaires available in 2700 K and other colour temperatures on request

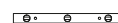

System examples

To calculate the overall length of the system, the lengths of the individual luminaire modules and the dimensions of the connection flanges or arms must be added together.

By combining luminaires of different lengths, the overall length of the system can be made to coincide with the dimensions of the surface to be illuminated.

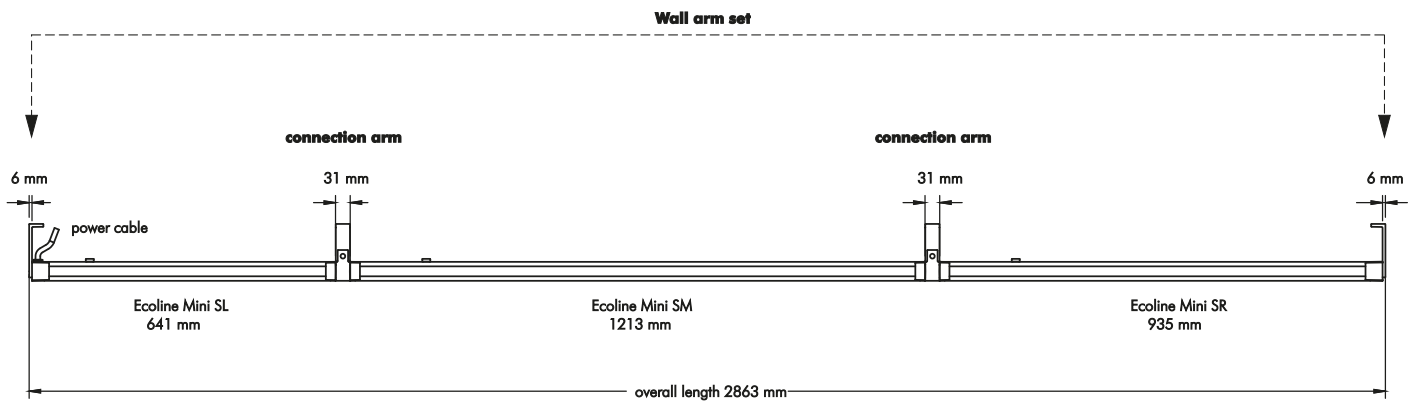
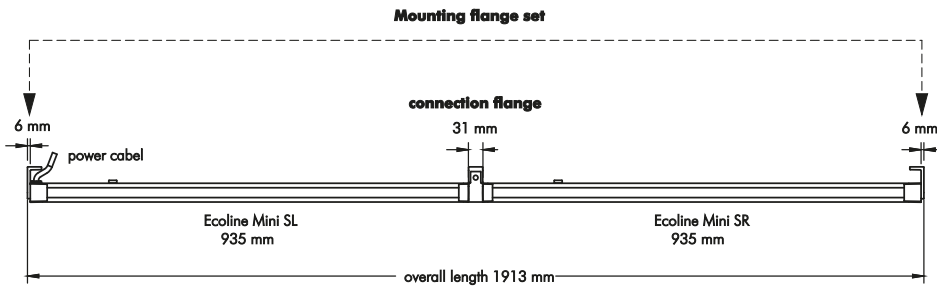



Monospot is a new floodlight series with innovative technology and design. It comes in 4 sizes with varying wattages. In addition to a wide range of fixed light distributions, there is also the Vario Optic version which allows the light beam to be adjusted to suit the specific lighting task.

The housings are free of joins and ridges, in or on which dirt and dust can collect. The puristic design and the compact dimensions allow these products to be integrated discreetly into any architectural surrounding.

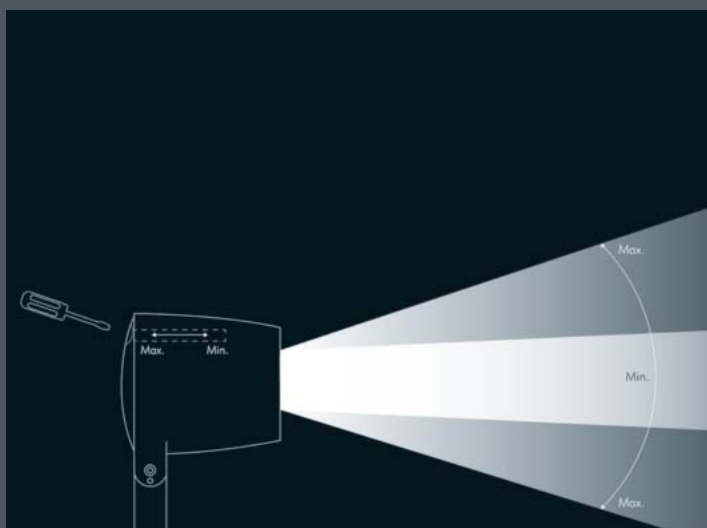

The Vario Optic makes it possible to adjust the beam angle. This is done from outside the luminaire so that the optimal beam angle can be achieved while the floodlight is switched on. This function offers a high degree of flexibility, for example in landscape lighting.

Monospot pole luminaires are equipped with a tilt-and-turn fixing system. A wide range of reflectors make it possible to create different lighting scenarios. The street optic produces a bat-wing type distribution for illuminating paths and driveways.



Since the LED modules are located deep inside the reflectors, the luminaires have good cut-off and excellent glare control. Accessories, such as louvres and optical glasses, are internally fitted and therefore maintenance-free.



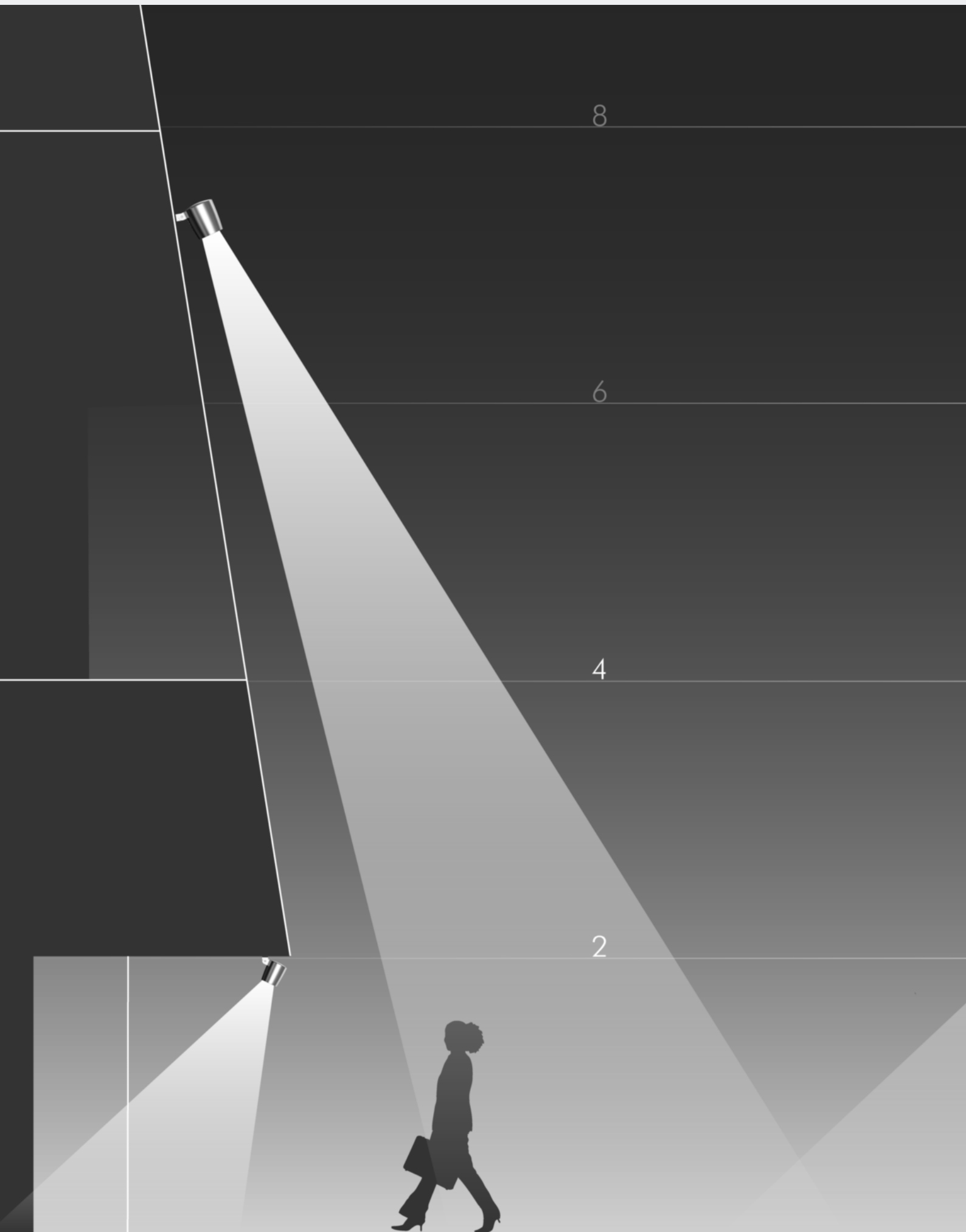

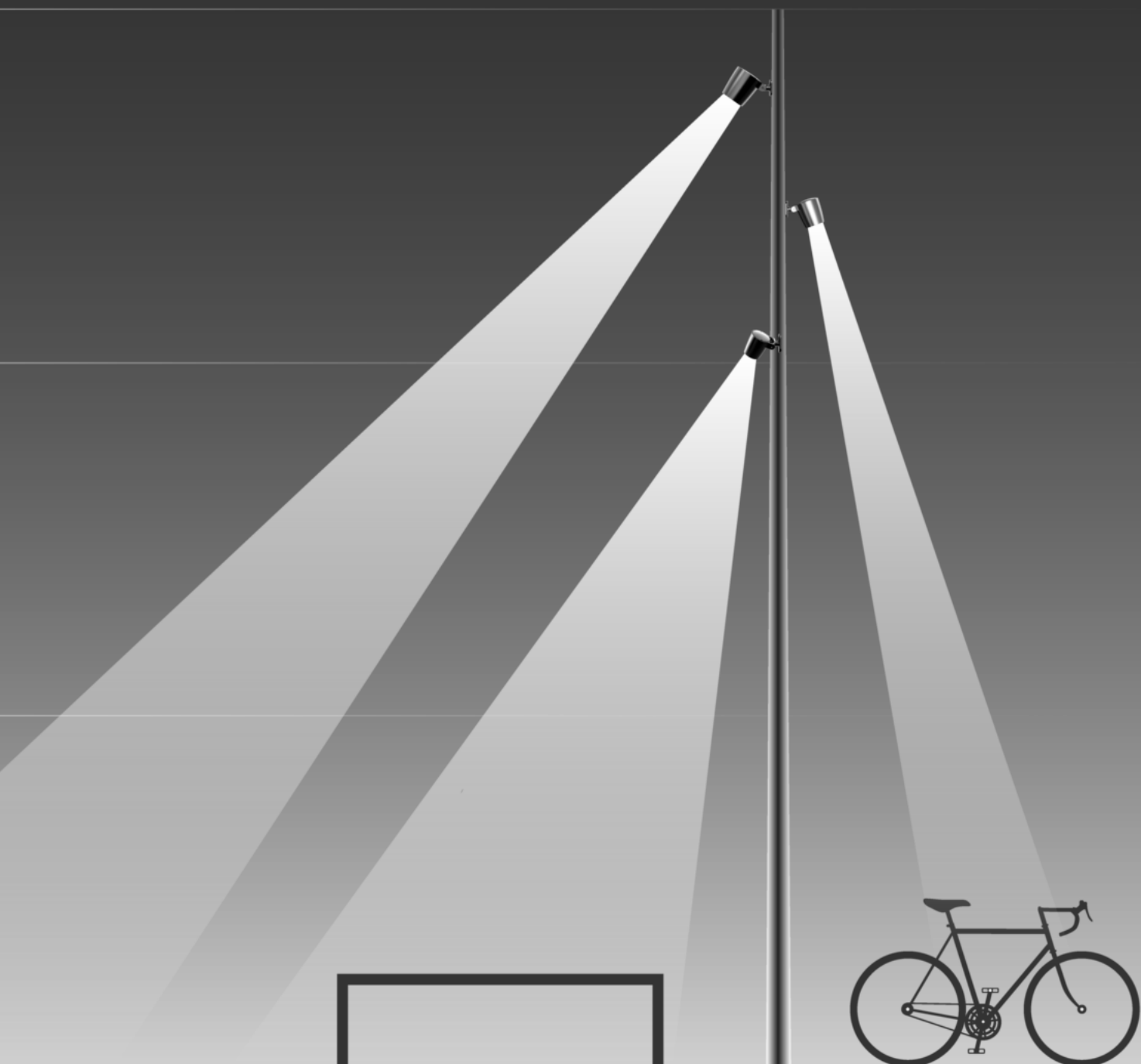

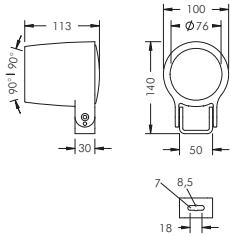

Monospot 1 with mounting bracket

With a high performance LED module (Zhaga), integral temperature monitoring device, CRI: > 80, Colour tolerance: max. 3 SDCM
 Service life: L90/B10 > 50 000 h
 protection class I, IP65 , IK08
 windage area AW 0.017 m²
 corrosion-resistant die cast aluminium housing AlSi12, polyester powder coated,
 all exterior steel parts are stainless steel, tempered safety glass, silicon gasket, closure with 2 stainless steel screws,
 mounting bracket: 1 elongated hole Ø 7 mm, spacing 18 mm, 1 centre hole Ø 8,5 mm, tilt range 180°, M16 cable gland, integral driver (AC/DC)

Monospot 1, narrow beam

Part number	Colour	Light source	Luminous flux	Beam angle γ (FWHM)
8 901 046 019	black	1 x LED module 6 W	431 lm	6°
8 901 066 019	white	warm white (3000 K)		
8 901 056 019	silver grey			

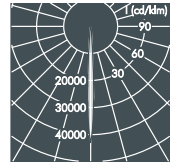
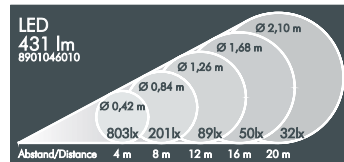

Part number	Colour	Light source	Luminous flux	Beam angle γ (FWHM)
8 901 045 019	black	1 x LED module 6 W	453 lm	6°
8 901 065 019	white	neutral white (4000 K)		
8 901 055 019	silver grey			

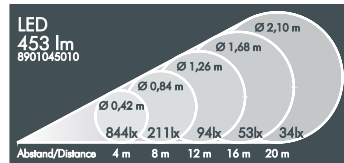

Monospot 1, linear beam spread, vertical

Part number	Colour	Light source	Luminous flux	Beam angle γ (FWHM)	
8 901 046 029	black	1 x LED module 6 W	452 lm	C 0 – 180	C 90 – 270
8 901 066 029	white	warm white (3000 K)		34°	7°
8 901 056 029	silver grey				

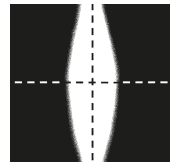
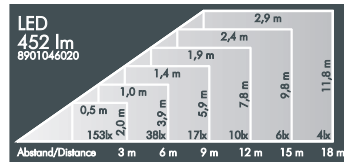

. 3. Luminaire with linear beam spread, horizontal

Monospot 1, linear beam spread, rotatable

Part number	Colour	Description	Luminous flux	Beam angle γ (FWHM)	
8 901 046 079	black	Luminaire with external ribbed glass spreader lens, continuously adjustable through 360° from outside the luminaire	416 lm	C 0 – 180	C 90 – 270
8 901 066 079	white			34°	7°
8 901 056 079	silver grey				

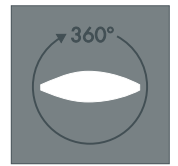

Monospot 1, medium wide beam

Part number	Colour	Light source	Luminous flux	Beam angle γ (FWHM)
8 901 046 049	black	1 x LED module 6 W	449 lm	34°
8 901 066 049	white	warm white (3000 K)		
8 901 056 049	silver grey			

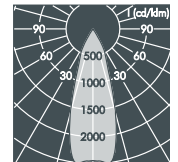
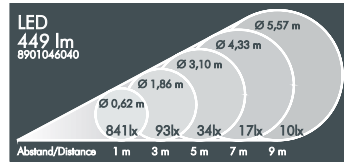

Monospot 1, wide beam

Part number	Colour	Light source	Luminous flux	Beam angle γ (FWHM)
8 901 046 059	black	1 x LED module 6 W	549 lm	44°
8 901 066 059	white	warm white (3000 K)		
8 901 056 059	silver grey			

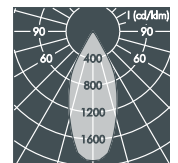
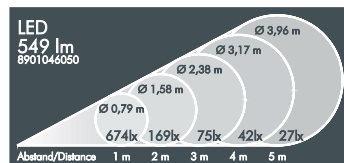

Part number	Colour	Light source	Luminous flux	Beam angle γ (FWHM)
8 901 045 059	black	1 x LED module 6 W	576 lm	44°
8 901 065 059	white	neutral white (4000 K)		
8 901 055 059	silver grey			

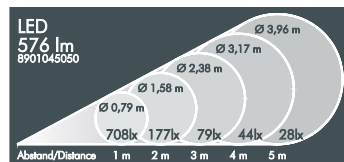

Part number	Description
. 5 . . .	Luminaire with neutral white colour temperature (4000 K)

LED

Luminaires available in 2700 K or other colour temperatures on request



Monospot 2 with mounting bracket

With a high performance LED module (Zhaga),
integral temperature monitoring device,
CRI: > 80, Colour tolerance: max. 3 SDCM
Service life: L90/B10 > 50 000 h
protection class I, IP65 , IK08
windage area AW 0.031 m²
corrosion-resistant die cast aluminium housing AlSi12,
polyester powder coated,
all exterior steel parts are stainless steel,
tempered safety glass, silicon gasket,
closure with 2 stainless steel screws,
mounting bracket: 2 drilled holes Ø 7 mm,
spacing 30 – 40 mm, 1 centre hole Ø 17 mm,
tilt range 180°, M16 cable gland,
integral driver (AC/DC)

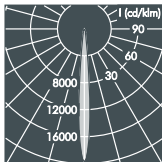
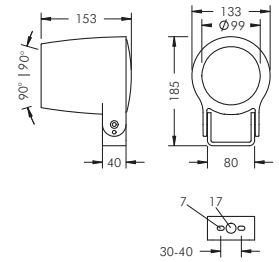

Abstand/Distance	4 m	8 m	12 m	16 m	20 m
Beam diameter	Ø 0,64 m	Ø 1,29 m	Ø 1,93 m	Ø 2,58 m	Ø 3,22 m
Luminous flux	977lx	244lx	109lx	61lx	39lx

Monospot 2, narrow beam

Part number	Colour	Light source	Luminous flux	Beam angle γ (FWHM)
8 902 046 019	black	1 x LED module 15 W	1095 lm	8°
8 902 066 019	white	warm white (3000 K)		
8 902 056 019	silver grey			



Abstand/Distance	4 m	8 m	12 m	16 m	20 m
Beam diameter	Ø 0,64 m	Ø 1,29 m	Ø 1,93 m	Ø 2,58 m	Ø 3,22 m
Luminous flux	1027lx	257lx	114lx	64lx	41lx

Part number	Colour	Light source	Luminous flux	Beam angle γ (FWHM)
8 902 045 019	black	1 x LED module 15 W	1151 lm	8°
8 902 065 019	white	neutral white (4000 K)		
8 902 055 019	silver grey			

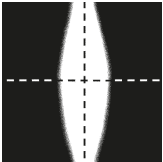

Abstand/Distance	3 m	6 m	9 m	12 m	15 m	18 m
Beam width	0,5 m	1,0 m	1,4 m	1,9 m	2,4 m	2,9 m
Luminous flux	395lx	240lx	99lx	44lx	25lx	11lx

Monospot 2, linear beam spread, vertical

Part number	Colour	Light source	Luminous flux	Beam angle γ (FWHM)
8 902 046 029	black	1 x LED module 15 W	1167 lm	C 0 – 180
8 902 066 029	white	warm white (3000 K)		35°
8 902 056 029	silver grey			8°

..... 3. Luminaire with linear beam spread, horizontal

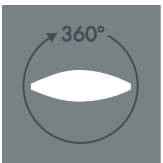

Monospot 2, linear beam spread, rotatable

Part number	Colour	Description	Luminous flux	Beam angle γ (FWHM)
8 901 046 079	black	Luminaire with external ribbed glass spreader lens, continuously adjustable through 360° from outside the luminaire	1008 lm	C 0 – 180
8 901 066 079	white			35°
8 901 056 079	silver grey			8°

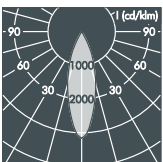

Abstand/Distance	2 m	4 m	6 m	8 m	10 m
Beam diameter	Ø 1,09 m	Ø 2,19 m	Ø 3,28 m	Ø 4,38 m	Ø 5,47 m
Luminous flux	556lx	139lx	62lx	35lx	22lx

Monospot 2, medium wide beam

Part number	Colour	Light source	Luminous flux	Beam angle γ (FWHM)
8 902 046 049	black	1 x LED module 15 W	1083 lm	31°
8 902 066 049	white	warm white (3000 K)		
8 902 056 049	silver grey			

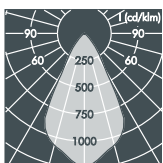

Abstand/Distance	1 m	3 m	5 m	7 m	9 m
Beam diameter	Ø 1,05 m	Ø 3,15 m	Ø 5,25 m	Ø 7,35 m	Ø 9,45 m
Luminous flux	873lx	97lx	35lx	18lx	11lx

Monospot 2, wide beam

Part number	Colour	Light source	Luminous flux	Beam angle γ (FWHM)
8 902 046 059	black	1 x LED module 15 W	1069 lm	55°
8 902 066 059	white	warm white (3000 K)		
8 902 056 059	silver grey			



Part number	Description
..... 5 ...	Luminaire with neutral white colour temperature (4000 K)
..... 1 ..	Dimmable luminaire (DALI)
..... 2 ..	Dimmable luminaire (1-10 V)

LED

Luminaires available in 2700 K or other colour temperatures on request



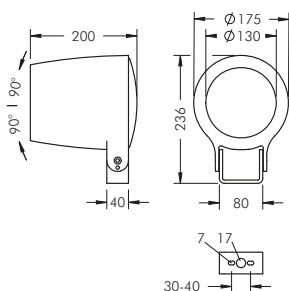

Monospot 3 with mounting bracket

With a high performance LED module (Zhaga), integral temperature monitoring device, CRI: > 80, Colour tolerance: 2 SDCM Service life: L90/B10 > 50 000 h protection class I, IP65 , IK08 windage area AW 0.049 m² corrosion-resistant die cast aluminium housing AlSi12, polyester powder coated, all exterior steel parts are stainless steel, tempered safety glass, silicon gasket, closure with 3 stainless steel screws, mounting bracket: 2 drilled holes \varnothing 7 mm, spacing 30 – 40 mm, 1 centre hole \varnothing 17 mm, tilt range 180°, M20 cable gland, integral driver (AC/DC)

Monospot 3, narrow beam

Part number	Colour	Light source	Luminous flux	Beam angle γ (FWHM)
8 903 046 019	black	1 x LED module 36 W	3289 lm	9°
8 903 066 019	white	warm white (3000 K)		
8 903 056 019	silver grey			

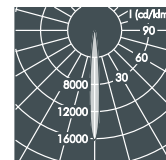
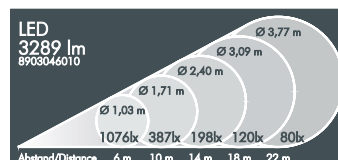

Part number	Colour	Light source	Luminous flux	Beam angle γ (FWHM)
8 903 045 019	black	1 x LED module 36 W	3391 lm	9°
8 903 065 019	white	neutral white (4000 K)		
8 903 055 019	silver grey			

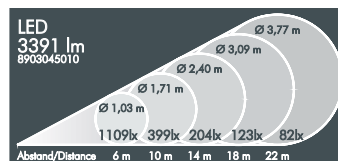

Monospot 3, linear beam spread, vertical

Part number	Colour	Light source	Luminous flux	Beam angle γ (FWHM)
8 903 046 029	black	1 x LED module 36 W	2829 lm	C 0 – 180
8 903 066 029	white	warm white (3000 K)		C 90 – 270
8 903 056 029	silver grey			36°

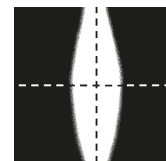
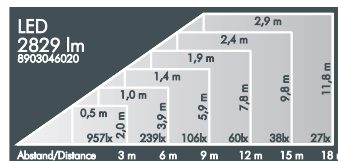

... .3. Luminaire with linear beam spread, horizontal

Monospot 3, linear beam spread, rotatable

Part number	Colour	Description	Luminous flux	Beam angle γ (FWHM)
8 903 046 079	black	Luminaire with external ribbed glass spreader lens, continuously adjustable through 360° from outside the luminaire	2603 lm	C 0 – 180
8 903 066 079	white			C 90 – 270
8 903 056 079	silver grey			36°

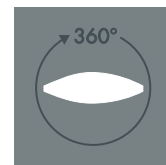

Monospot 3, medium wide beam

Part number	Colour	Light source	Luminous flux	Beam angle γ (FWHM)
8 903 046 049	black	1 x LED module 36 W	3283 lm	30°
8 903 066 049	white	warm white (3000 K)		
8 903 056 049	silver grey			

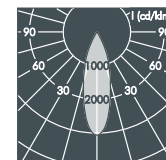
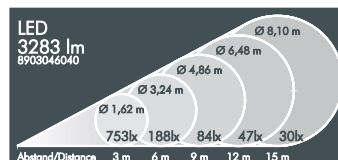

Monospot 3, wide beam

Part number	Colour	Light source	Luminous flux	Beam angle γ (FWHM)
8 903 046 059	black	1 x LED module 36 W	3348 lm	53°
8 903 066 059	white	warm white (3000 K)		
8 903 056 059	silver grey			

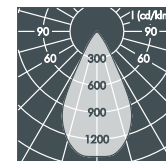
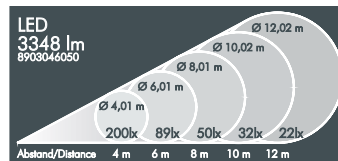

Part number	Description
... .5 ...	Luminaire with neutral white colour temperature (4000 K)
... .1 ..	Dimmable luminaire (DALI)
... .2 ..	Dimmable luminaire (1-10 V)



LED

Luminaires available in 2700 K or other colour temperatures on request



Monospot 3 Vario Optic with mounting bracket

With a high performance LED module (Zhaga), integral temperature monitoring device, CRI: > 80, Colour tolerance: 2 SDCM
 Service life: L80/B20 > 50 000 h
 protection class I, IP65 , IK08
 windage area AW 0.049 m²
 corrosion-resistant die cast aluminium housing AlSi12, polyester powder coated,
 high transmission glass optical lens,
 beam angle adjustable from outside the luminaire,
 all exterior steel parts are stainless steel,
 tempered safety glass, silicon gasket,
 closure with 3 stainless steel screws,
 mounting bracket: 2 drilled holes \varnothing 7 mm, spacing 30 – 40 mm, 1 centre hole \varnothing 17 mm, tilt range 180°, M20 cable gland, integral driver (AC/DC)

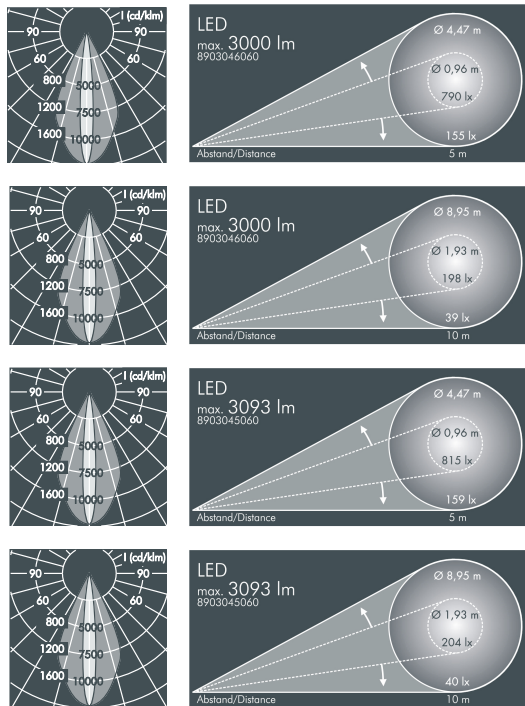
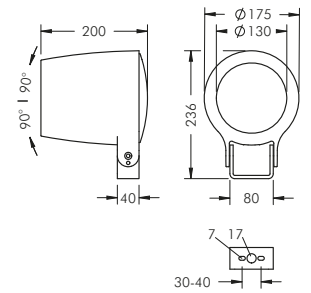

Monospot 3 Vario Optic

Part number	Colour	Light source	Luminous flux	Beam angle γ (FWHM)
8 903 046 069	black	1 x LED module 36 W	max. 3000 lm	11°-48°
8 903 066 069	white	warm white (3000 K)		
8 903 056 069	silver grey			

Part number	Colour	Light source	Luminous flux	Beam angle γ (FWHM)
8 903 045 069	black	1 x LED module 36 W	max. 3093 lm	11°-48°
8 903 065 069	white	neutral white (4000 K)		
8 903 055 069	silver grey			

Part number	Description
... 1 ..	Dimmable luminaire (DALI)
... 2 ..	Dimmable luminaire (1-10 V)

LED

Luminaires available in 2700 K or other colour temperatures on request



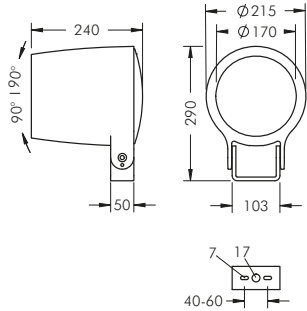

Monospot 4 with mounting bracket

With a high performance LED module (Zhaga), integral temperature monitoring device, CRI: > 80, Colour tolerance: 2 SDCM
 Service life: L90/B10 > 50 000 h
 protection class I, IP65 , IK08
 windage area AW 0.075 m²
 corrosion-resistant die cast aluminium housing AlSi12, polyester powder coated,
 all exterior steel parts are stainless steel, tempered safety glass,
 silicon gasket, closure with 3 stainless steel screws,
 mounting bracket: 2 drilled holes Ø 7 mm, spacing 40 – 60 mm, 1 centre hole Ø 17 mm,
 tilt range 180°, M20 cable gland,
 integral driver (AC/DC)

Monospot 4, narrow beam

Part number	Colour	Light source	Luminous flux	Beam angle γ (FWHM)
8 904 046 019	black	1 x LED module 70 W	5664 lm	9°
8 904 066 019	white	warm white (3000 K)		
8 904 056 019	silver grey			

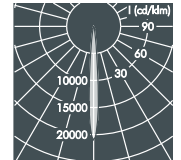
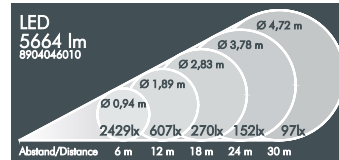

Artikelnummer	Colour	Light source	Luminous flux	Beam angle γ (FWHM)
8 904 045 019	black	1 x LED module 70 W	5947 lm	9°
8 904 065 019	white	neutral white (4000 K)		
8 904 055 019	silver grey			

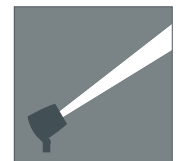
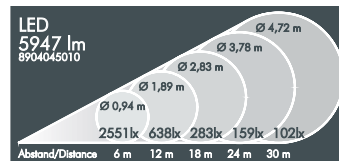

Monospot 4, linear beam spread, vertical

Part number	Colour	Light source	Luminous flux	Beam angle γ (FWHM)
8 904 046 029	black	1 x LED module 70 W	4909 lm	C 0 – 180 36°
8 904 066 029	white	warm white (3000 K)		C 90 – 270 9°
8 904 056 029	silver grey			

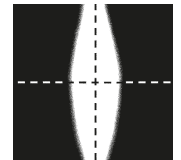
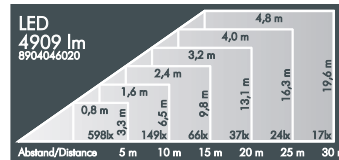

... .3. Luminaire with linear beam spread, horizontal

Monospot 4, linear beam spread, rotatable

Part number	Colour	Description	Luminous flux	Beam angle γ (FWHM)
8 904 046 079	black	Luminaire with external ribbed glass spreader lens, continuously adjustable through 360° from outside the luminaire	4517 lm	C 0 – 180 36°
8 904 066 079	white			C 90 – 270 9°
8 904 056 079	silver grey			

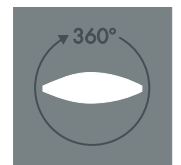

Monospot 4, medium wide beam

Part number	Colour	Light source	Luminous flux	Beam angle γ (FWHM)
8 904 046 049	black	1 x LED module 70 W	5746 lm	36°
8 904 066 049	white	warm white (3000 K)		
8 904 056 049	silver grey			

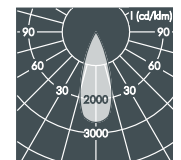
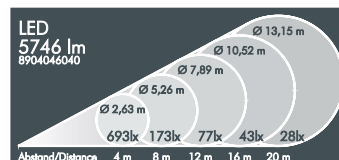

Monospot 4, wide beam

Part number	Colour	Light source	Luminous flux	Beam angle γ (FWHM)
8 904 046 059	black	1 x LED module 70 W	5573 lm	57°
8 904 066 059	white	warm white (3000 K)		
8 904 056 059	silver grey			

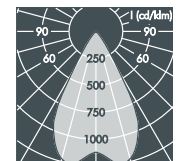
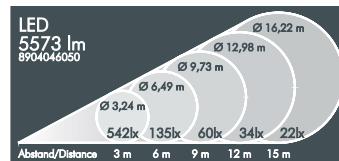

Part number	Description
... .5 ...	Luminaire with neutral white colour temperature (4000 K)
... .1 ...	Dimmable luminaire (DALI)
... .2 ...	Dimmable luminaire (1-10 V)
... .9 ...	Luminaire with LED module RGBW max. 49 W
... .2 ...	Luminaire with Tunable White LED

LED

Luminaires available in 2700 K or other colour temperatures on request



Monospot 2 pole luminaire

With a high performance LED module (Zhaga), integral temperature monitoring device, CRI: > 80, Colour tolerance: 3 SDCM
 Service life: L90/B10 > 50 000 h
 protection class I, IP65 , IK08
 windage area AW 0.031 m²
 corrosion-resistant die cast aluminium housing AlSi12, polyester powder coated,
 all exterior steel parts are stainless steel, tempered safety glass, silicon gasket, closure with 2 stainless steel screws,
 for installation on poles Ø 60 - 100 mm, tiltable base made of powder coated aluminium,
 2 drilled holes Ø 9 mm, spacing 95 mm, 1 centre hole Ø 13.5 mm, tilt range 90°, swivel range 360°, M16 cable gland, integral driver (AC/DC)

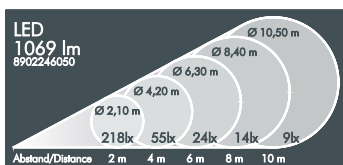
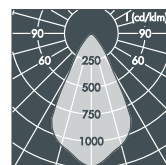
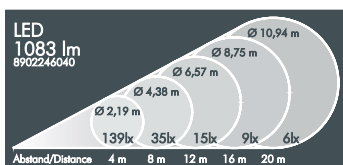
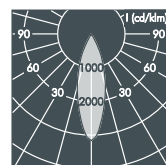
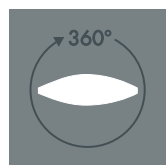
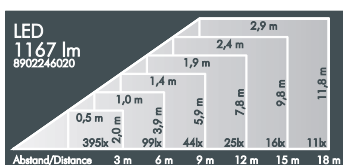
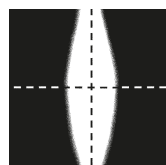
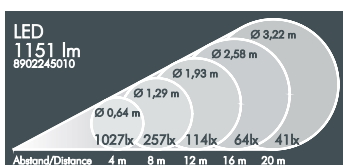
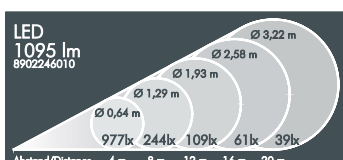
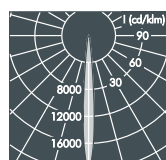
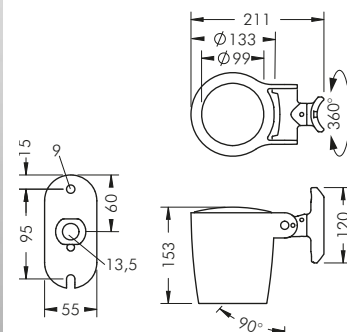

LED

Luminaires available in 2700 K or other colour temperatures on request



Monospot 2 pole luminaire, narrow beam

Part number	Colour	Light source	Luminous flux	Beam angle γ (FWHM)
8 902 246 019	black	1 x LED module 15 W	1095 lm	8°
8 902 266 019	white	warm white (3000 K)		
8 902 256 019	silver grey			

Part number	Colour	Light source	Luminous flux	Beam angle γ (FWHM)
8 902 245 019	black	1 x LED module 15 W	1151 lm	8°
8 902 265 019	white	neutral white (4000 K)		
8 902 255 019	silver grey			

Monospot 2 pole luminaire, linear beam spread, vertical

Part number	Colour	Light source	Luminous flux	Beam angle γ (FWHM)
8 902 246 029	black	1 x LED module 15 W	1167 lm	C 0 – 180 35°
8 902 266 029	white	warm white (3000 K)		C 90 – 270 8°
8 902 256 029	silver grey			

.3. Luminaire with linear beam spread, horizontal

Monospot 2 pole luminaire, linear beam spread, rotatable

Part number	Colour	Description	Luminous flux	Beam angle γ (FWHM)
8 902 246 079	black	Luminaire with external ribbed glass spreader lens, continuously adjustable through 360° from outside the luminaire	1008 lm	C 0 – 180 35°
8 902 266 079	white			
8 902 256 079	silver grey			

Monospot 2 pole luminaire, medium wide beam

Part number	Colour	Light source	Luminous flux	Beam angle γ (FWHM)
8 902 246 049	black	1 x LED module 15 W	1083 lm	31°
8 902 266 049	white	warm white (3000 K)		
8 902 256 049	silver grey			

Monospot 2 pole luminaire, wide beam

Part number	Colour	Light source	Luminous flux	Beam angle γ (FWHM)
8 902 246 059	black	1 x LED module 15 W	1069 lm	55°
8 902 266 059	white	warm white (3000 K)		
8 902 256 059	silver grey			

Part number	Description
.5 . . .	Luminaire with neutral white colour temperature (4000 K)
.1 . .	Dimmable luminaire (DALI)
.2 . .	Dimmable luminaire (1-10 V)

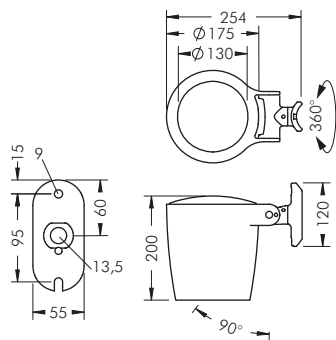

Monospot 3 pole luminaire

With a high performance LED module (Zhaga), integral temperature monitoring device, CRI: > 80, Colour tolerance: 2 SDCM
 Service life: L90/B10 > 50 000 h
 protection class I, IP65 , IK08
 windage area AW 0.049 m²
 corrosion-resistant die cast aluminium housing AlSi12, polyester powder coated,
 all exterior steel parts are stainless steel, tempered safety glass, silicon gasket, closure with 3 stainless steel screws, for installation on poles Ø 60 - 100 mm, tiltable base made of powder coated aluminium, 2 drilled holes Ø 9 mm, spacing 95 mm, 1 drilled hole Ø 13.5 mm, tilt range 90°, swivel range 360°, M20 cable gland, integral driver (AC/DC)

Monospot 3 pole luminaire, narrow beam

Part number	Colour	Light source	Luminous flux	Beam angle γ (FWHM)
8 903 246 019	black	1 x LED module 36 W	3289 lm	9°
8 903 266 019	white	warm white (3000 K)		
8 903 256 019	silver grey			

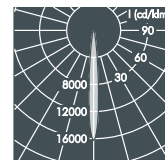
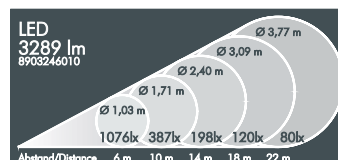

Part number	Colour	Light source	Luminous flux	Beam angle γ (FWHM)
8 903 245 019	black	1 x LED module 36 W	3391 lm	9°
8 903 265 019	white	neutral white (4000 K)		
8 903 255 019	silver grey			

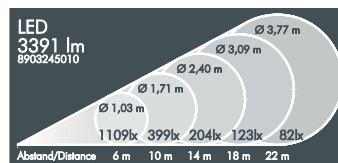

Monospot 3 pole luminaire, linear beam spread, vertical

Part number	Colour	Light source	Luminous flux	Beam angle γ (FWHM)
8 903 246 029	black	1 x LED module 36 W	2829 lm	C 0 - 180
8 903 266 029	white	warm white (3000 K)		C 90 - 270
8 903 256 029	silver grey			36°

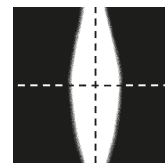
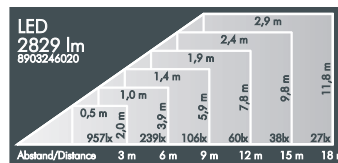

... .3. Luminaire with linear beam spread, horizontal

Monospot 3 pole luminaire, linear beam spread, rotatable

Part number	Colour	Description	Luminous flux	Beam angle γ (FWHM)
8 903 246 079	black	Luminaire with external ribbed glass spreader lens, continuously adjustable through 360° from outside the luminaire	2603 lm	C 0 - 180
8 903 266 079	white			C 90 - 270
8 903 256 079	silver grey			36°

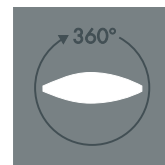

Monospot 3 pole luminaire, medium wide beam

Part number	Colour	Light source	Luminous flux	Beam angle γ (FWHM)
8 903 246 049	black	1 x LED module 36 W	3283 lm	30°
8 903 266 049	white	warm white (3000 K)		
8 903 256 049	silver grey			

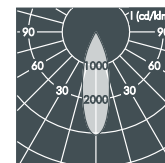
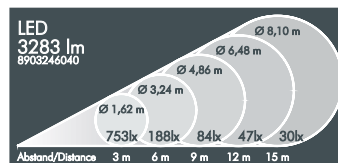

Monospot 3 pole luminaire, wide beam

Part number	Colour	Light source	Luminous flux	Beam angle γ (FWHM)
8 903 246 059	black	1 x LED module 36 W	3348 lm	53°
8 903 266 059	white	warm white (3000 K)		
8 903 256 059	silver grey			

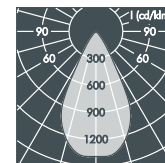
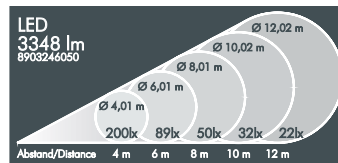

Part number	Description
... .5 ...	Luminaire with neutral white colour temperature (4000 K)
... .1 ..	Dimmable luminaire (DALI)
... .2 ..	Dimmable luminaire (1-10 V)

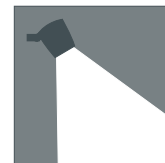

LED

Luminaires available in 2700 K or other colour temperatures on request



Monospot 3 Vario Optic pole luminaire

With a high performance LED module (Zhaga), integral temperature monitoring device, CRI: > 80, Colour tolerance: 2 SDCM
 Service life: L80/B20 > 50 000 h
 protection class I, IP65 , IK08
 windage area AW 0.049 m²
 corrosion-resistant die cast aluminium housing AlSi12, polyester powder coated,
 high transmission glass optical lens,
 beam angle adjustable from outside the luminaire,
 all exterior steel parts are stainless steel,
 tempered safety glass, silicon gasket,
 closure with 3 stainless steel screws,
 for installation on poles Ø 60 - 100 mm,
 tiltable base made of powder coated aluminium,
 2 drilled holes Ø 9 mm, spacing 95 mm,
 1 drilled hole Ø 13.5 mm, tilt range 90°,
 swivel range 360°, M20 cable gland,
 integral driver (AC/DC)

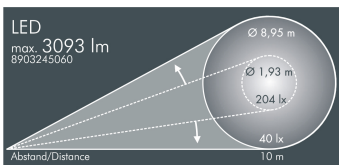
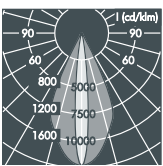
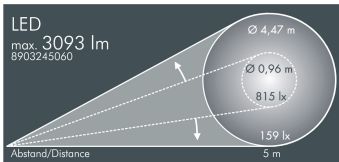
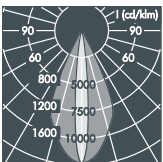
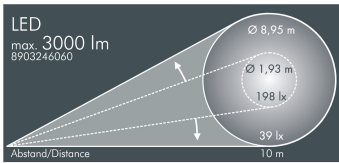
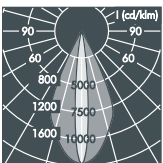
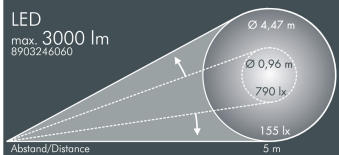
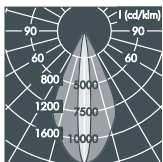
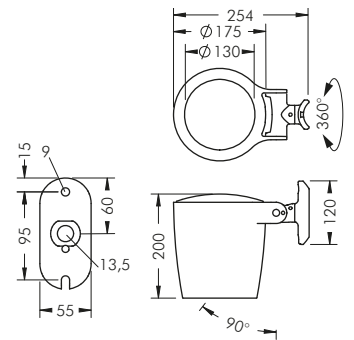

Monospot 3 Vario Optic, pole luminaire

Part number	Colour	Light source	Luminous flux	Beam angle γ (FWHM)
8 903 246 069	black	1 x LED module 36 W	max. 3000 lm	11°-48°
8 903 266 069	white	warm white (3000 K)		
8 903 256 069	silver grey			

Part number	Colour	Light source	Luminous flux	Beam angle γ (FWHM)
8 903 245 069	black	1 x LED module 36 W	max. 3093 lm	11°-48°
8 903 265 069	white	neutral white (4000 K)		
8 903 255 069	silver grey			

Part number	Description
... 1 ..	Dimmable luminaire (DALI)
... 2 ..	Dimmable luminaire (1-10 V)

LED

Luminaires available in 2700 K or other colour temperatures on request



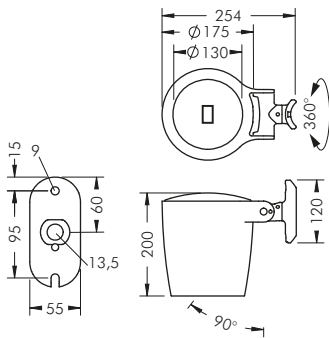

Monospot 3 Street Optic pole luminaire

With a high performance LED module (Zhaga), integral temperature monitoring device, CRI: > 80, Colour tolerance: 2 SDCM
 Service life: L90/B10 > 50 000 h
 protection class I, IP65 , IK08
 windage area AW 0.049 m²
 corrosion-resistant die cast aluminium housing AlSi12, polyester powder coated, lense made of high efficiency, UV stabilized optical silicon, all exterior steel parts are stainless steel, tempered safety glass, silicon gasket, closure with 3 stainless steel screws, for installation on poles Ø 60-100 mm, tiltable base made of powder coated aluminium, 2 drilled holes Ø 9 mm, spacing 95 mm, 1 drilled hole Ø 13.5 mm, tilt range 90°, swivel range 360°, M20 cable gland, integral driver (AC/DC)

Monospot 3 Street optic luminaire

Part number	Colour	Light source	Luminous flux	Beam angle γ (FWHM)	
8 903 246 089	black	1 x LED module 36 W	3236 lm	C 0 – 180	C 90 – 270
8 903 266 089	white	warm white (3000 K)		51°	121°
8 903 256 089	silver grey				

Part number	Colour	Light source	Luminous flux	Beam angle γ (FWHM)	
8 903 245 089	black	1 x LED module 36 W	3374 lm	C 0 – 180	C 90 – 270
8 903 265 089	white	neutral white (4000 K)		51°	121°
8 903 255 089	silver grey				

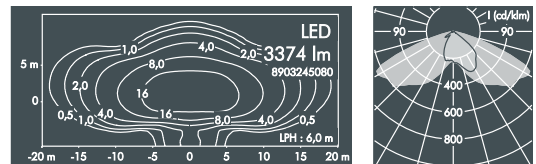
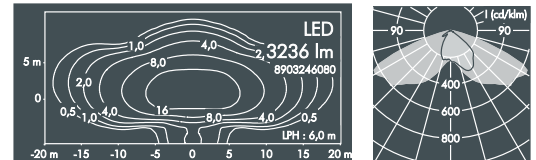

Part number	Description
. 1 . .	Dimmable luminaire (DALI)

Illumination examples (according to DIN EN 13201-2)

	Lighting situation			
	S(P)2	S(P)3	S(P)4	S(P)5
LPH	6 m	6 m	6 m	6 m
D	30 m	35 m	37 m	41 m
D/H	5	5.8	6.2	6.8
Em	9.3 lx	8 lx	7.5 lx	6.8 lx
E_{min}	3.1 lx	1.5 lx	1.0 lx	0.6 lx
E_{min}/E_m	0.33	0.19	0.13	0.1
TI*	11%	12%	13%	14%

* TI: Threshold Increment (unit for measuring glare).
 A low TI value indicates a low glare factor.

LED

Luminaires available in 2700 K or other colour temperatures on request



Monospot 4 pole luminaire

With a high performance LED module (Zhaga),
 integral temperature monitoring device,
 CRI: > 80, Colour tolerance: 2 SDCM
 Service life: L90/B10 > 50 000 h
 protection class I, IP65 $\diamond \triangle \triangle$, IK08
 windage area AW 0,075 m²
 corrosion-resistant die cast aluminium housing AlSi12,
 polyester powder coated,
 all exterior steel parts are stainless steel,
 tempered safety glass, silicon gasket,
 closure with 3 stainless steel screws,
 for installation on poles \varnothing 60-100 mm,
 tiltable base made of powder coated aluminium,
 2 drilled holes \varnothing 9 mm, spacing 95 mm,
 1 drilled hole \varnothing 13.5 mm, tilt range 90°,
 swivel range 360°, M20 cable gland,
 integral driver (AC/DC)

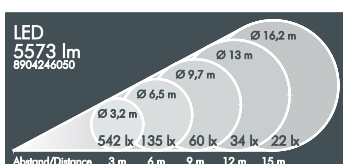
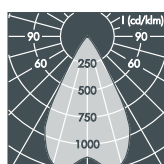
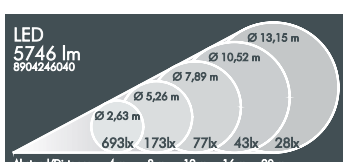
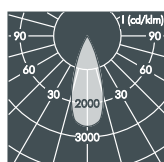
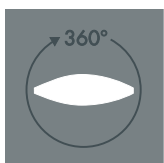
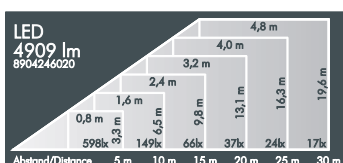
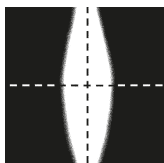
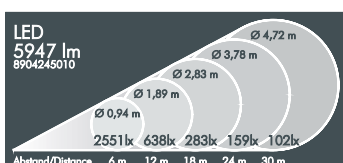
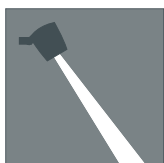
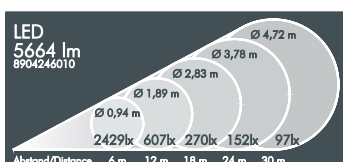
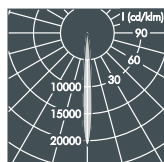
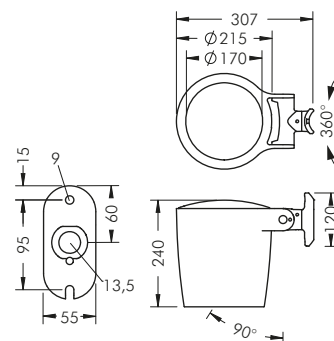

Monospot 4 pole luminaire, narrow beam

Part number	Colour	Light source	Luminous flux	Beam angle γ (FWHM)
8 904 246 019	black	1 x LED module 70 W	5664 lm	9°
8 904 266 019	white	warm white (3000 K)		
8 904 256 019	silver grey			

Part number	Colour	Light source	Luminous flux	Beam angle γ (FWHM)
8 904 245 019	black	1 x LED module 70 W	5947 lm	9°
8 904 265 019	white	neutral white (4000 K)		
8 904 255 019	silver grey			

Monospot 4 pole luminaire, linear beam spread, vertical

Part number	Colour	Light source	Luminous flux	Beam angle γ (FWHM)
8 904 246 029	black	1 x LED module 70 W	4909 lm	C 0 - 180
8 904 266 029	white	warm white (3000 K)		C 90 - 270
8 904 256 029	silver grey			36°

Monospot 4 pole luminaire, linear beam spread, horizontal

Monospot 4 pole luminaire, linear beam spread, rotatable

Part number	Colour	Description	Luminous flux	Beam angle γ (FWHM)
8 904 246 079	black	Luminaire with external ribbed glass spreader lens, continuously adjustable through 360° from outside the luminaire	4517 lm	C 0 - 180
8 904 266 079	white			C 90 - 270
8 904 256 079	silver grey			36°

Monospot 4 pole luminaire, medium wide beam

Part number	Colour	Light source	Luminous flux	Beam angle γ (FWHM)
8 904 246 049	black	1 x LED module 70 W	5746 lm	36°
8 904 266 049	white	warm white (3000 K)		
8 904 256 049	silver grey			

Monospot 4 pole luminaire, wide beam

Part number	Colour	Light source	Luminous flux	Beam angle γ (FWHM)
8 904 246 059	black	1 x LED module 70 W	5573 lm	57°
8 904 266 059	white	warm white (3000 K)		
8 904 256 059	silver grey			

Part number	Description
5	Luminaire with neutral white colour temperature (4000 K)
1	Dimmable luminaire (DALI)
2	Dimmable luminaire (1-10 V)
9	Luminaire with LED module RGBW max. 49 W
2	Luminaire with Tunable White LED

LED

Luminaires available in 2700 K or other colour temperatures on request



Accessories Monospot internal, **factory fitted**

Monospot 2

Part number	Description
129 0 728 940	Radial louvre , internal (factory fitted), to reduce lateral glare



Monospot 3

Part number	Description
129 0 729 940	Radial louvre , internal (factory fitted), to reduce lateral glare



Monospot 4

Part number	Description
129 0 730 940	Radial louvre , internal (factory fitted), to reduce lateral glare

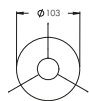
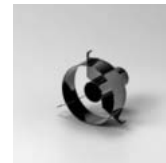

Monospot 1

Part number	Description	Beam angle γ (FWHM)	
		narrow beam	medium wide beam
129 0 732 000	Prismatic glass , for diffused light distribution	15°	41°



Monospot 2

Part number	Description	Beam angle γ (FWHM)	
		narrow beam	medium wide beam
129 0 733 000	Prismatic glass , for diffused light distribution	17°	38°



Monospot 3

Part number	Description	Beam angle γ (FWHM)	
		narrow beam	medium wide beam
129 0 734 000	Prismatic glass , for diffused light distribution	18°	37°



Monospot 4

Part number	Description	Beam angle γ (FWHM)	
		narrow beam	medium wide beam
129 0 735 000	Prismatic glass , for diffused light distribution	19°	46°

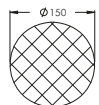

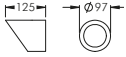

Monospot 1

Part number	Colour	Description
129 0 722 940	black	Cowl , stainless steel, to avoid lateral glare, for retro-fitting
129 0 722 960	white	
129 0 722 950	silver grey	

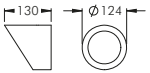

Monospot 2

Part number	Colour	Description
129 0 723 940	black	Cowl , stainless steel, to avoid lateral glare, for retro-fitting
129 0 723 960	white	
129 0 723 950	silver grey	

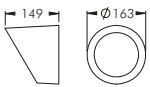

Monospot 3

Part number	Colour	Description
129 0 724 940	black	Cowl , stainless steel, to avoid lateral glare, for retro-fitting
129 0 724 960	white	
129 0 724 950	silver grey	

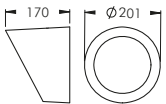

Monospot 4

Part number	Colour	Description
129 0 725 940	black	Cowl , stainless steel, to avoid lateral glare, for retro-fitting
129 0 725 960	white	
129 0 725 950	silver grey	

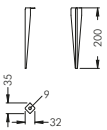

Monospot 1

Part number	Colour	Description
129 0 731 940	black	Stainless steel earth spike , for use in landscape lighting
129 0 731 960	white	
129 0 731 950	silver grey	

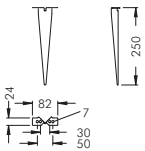

Monospot 2

Part number	Colour	Description
129 0 502 940	black	Stainless steel earth spike , for use in landscape lighting
129 0 502 960	white	
129 0 502 950	silver grey	

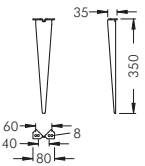

Monospot 3+4

Part number	Colour	Description
129 0 736 940	black	Stainless steel earth spike , for use in landscape lighting
129 0 736 960	white	
129 0 736 950	silver grey	





Uplight 180 complements the existing range of in-ground uplighters with a product of very compact dimensions. It offers all the relevant product advantages: precise light distribution, optimal glare control, adjustable optics, shallow depth. This unique combination of technical advantages is made possible by a well-thought-out product design, right down to the last detail.

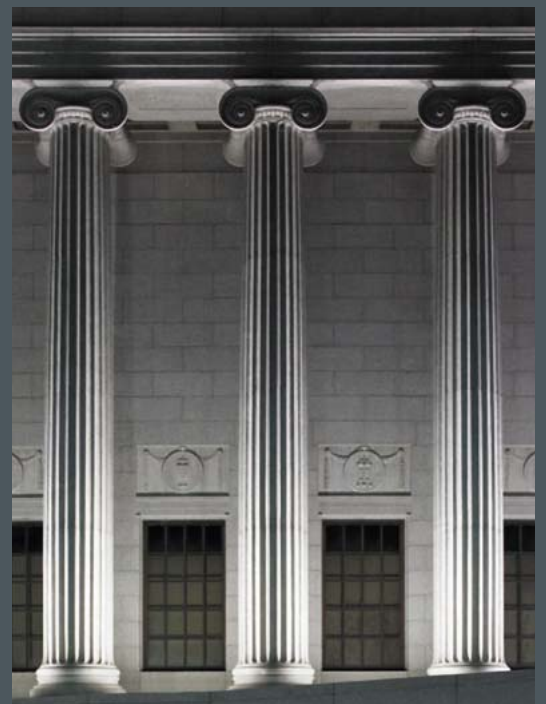

Uplight 180 adjustable optics

With a high performance LED module (Zhaga), integral temperature monitoring device, CRI: > 80, Colour tolerance: 3 SDCM
 Service life: L90/B10 > 50 000 h
 Protection class I, IP68 (1.5 m) ◆ ▲ ▲, IK10
 corrosion-resistant die cast aluminium housing AlSi12, double powder coated,
 high gloss aluminium reflector, tilt range 0-15°, lockable, all exterior steel parts are stainless steel, tempered safety glass, for loads up to max. 5000 kg (according to DIN EN 60598-2-13), silicon gasket, V4A stainless steel trim ring and closure with 6 screws (V4A), M20 cable gland, with 0.8 m cable H07RN-F3G1, integral driver (AC/DC)

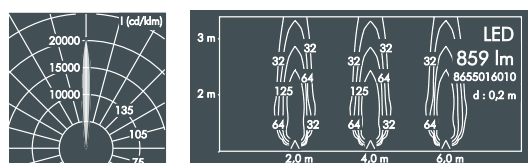
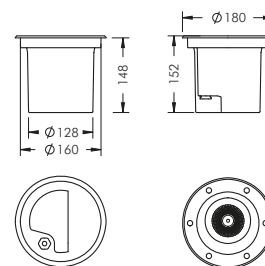

Uplight 180, adjustable optics, narrow beam

Part number	Light source	Luminous flux	Tilt range	Beam angle γ (FWHM)
8 655 016 019	1 x LED module 11 W warm white (3000 K)	859 lm	0 – 15°	8°

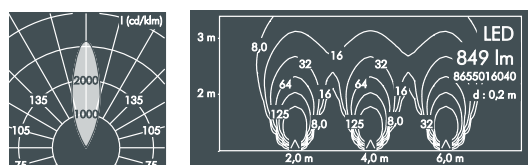

Uplight 180, adjustable optics, medium wide beam

Part number	Light source	Luminous flux	Tilt range	Beam angle γ (FWHM)
8 655 016 049	1 x LED module 11 W warm white (3000 K)	849 lm	0 – 15°	31°

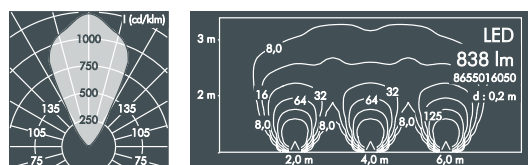

Uplight 180, adjustable optics, wide beam

Part number	Light source	Luminous flux	Tilt range	Beam angle γ (FWHM)
8 655 016 059	1 x LED module 11 W warm white (3000 K)	838 lm	0 – 15°	55°

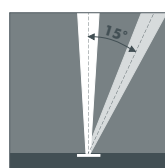

Part number	Description
. 5 . . .	Luminaire with neutral white colour temperature (4000 K)
8 656	Luminaire for installation flush with surrounding surface (in combination with installation sleeve 126 0 371 060)

Accessories Uplight 180

Part number	Description
126 0 371 000	Installation sleeve , polypropylene, for luminaire with overlapping trim (for luminaires 8 655 9)

Part number	Description
126 0 371 060	Installation sleeve , polypropylene, for luminaire with trim for flush mounting (for luminaires 8 656 9)

Part number	Description
126 0 372 940	Radial louvre to reduce lateral glare
126 0 340 000	Ribbed glass for linear beam control, continuously adjustable through 360°

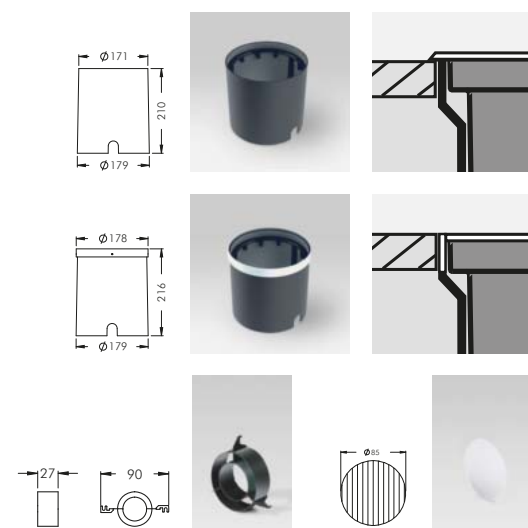

LED

Luminaires available in 2700 K or other colour temperatures on request





Willy Meyer+Sohn GmbH+Co. KG
Stemmessiepener Weg 5
D-58675 Hemer
Telephone: +49 (0) 23 72/98 91-0
Telefax: +49 (0) 23 72/98 91-48
E-mail: info@meyer-lighting.com
www.meyer-lighting.com