

# MONTAGEANWEISUNG

INSTRUCTION OF ASSEMBLY

## LUNA BL

### LED WANNENLEUCHE - LED DAMPPROOF

# PRACHT®

Zertifiziert nach DIN ISO 9001

Alfred Pracht Lichttechnik GmbH | Pracht Leuchten GmbH  
Am Seerain 3, 35232 Dautphetal-Buchenau, Germany  
Tel. +49 6466 9140-0, Fax +49 6466 9140-444  
info@pracht.com, www.praecht.com

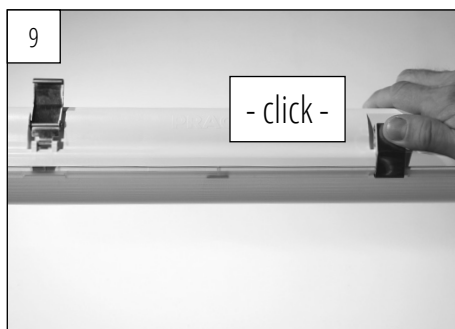
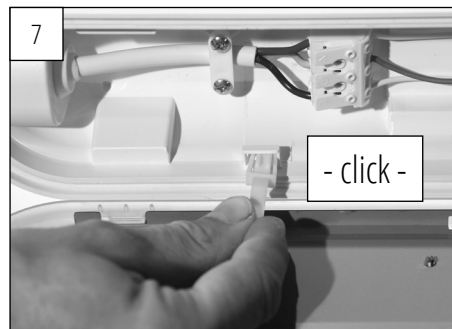
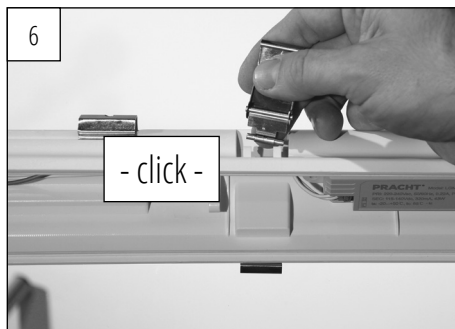
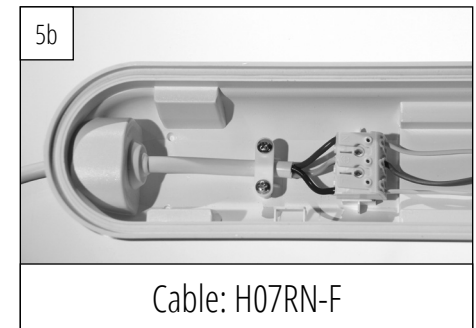
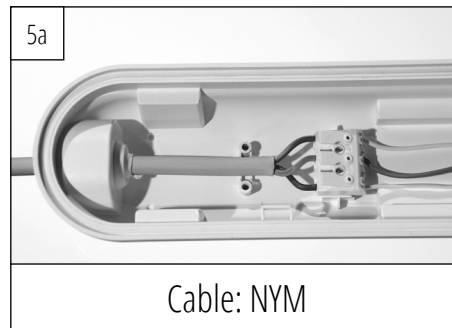
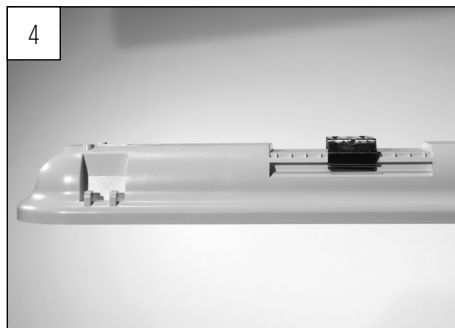
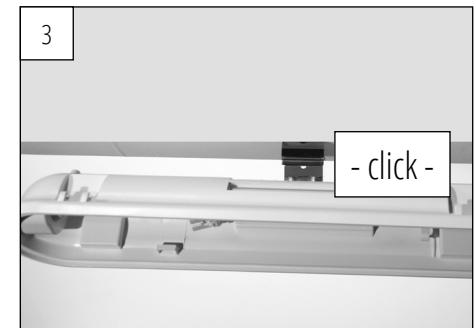
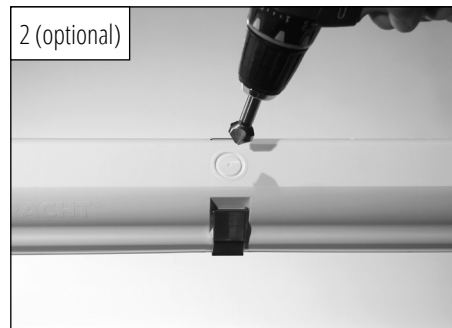
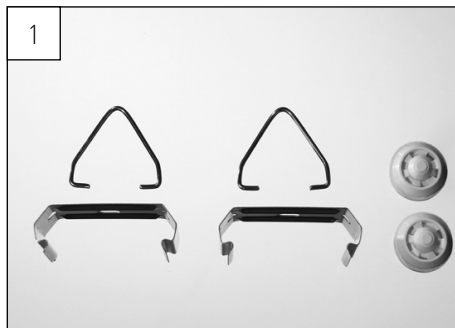

#### WICHTIGE HINWEISE:

Austausch des LED-Modul nicht möglich!

#### IMPORTANT INFORMATION:

Replacement of the LED module can not be performed!



Zur Verwendung in einer Umgebung in der eine Ablagerung von leitfähigem Staub auf der Leuchte erwartet werden kann.

This luminaire is useable in an environment that is expected to deposit conductive dust.

#### REINIGUNGSHINWEISE:

Verwendung von chemischen Reinigungsmittel begrenzt möglich. Nur für Polycarbonat geeignete Reinigungsmittel verwenden. Reinigungsmittel Rückstände müssen vollständig entfernt werden.

#### CLEANING NOTE:

Chemical cleaner only limited possible. Use only polycarbonate suitable cleaner. Chemical residues have to be completely removed.

#### HOT-PLUGGING:

Leuchte bitte erst nach vollständiger Montage in Betrieb nehmen.  
Please turn on luminaire only after completed installation.



# PRACHT® - LUNA BL

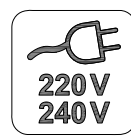
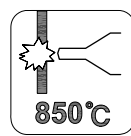
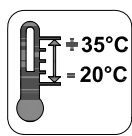

| Leistung<br>Watt | CCT<br>(k) | CRI | mm     |                                  |        |    |           |    |
|------------------|------------|-----|--------|----------------------------------|--------|----|-----------|----|
|                  |            |     | A      | B                                | C      | D  | E         | F  |
| 22               | 4000       |     | 78 ± 2 | 1200 <sup>+1</sup> <sub>-2</sub> | 90 ± 2 | 60 | 750 ± 50  | 79 |
| 43               |            |     |        | 1500 <sup>+1</sup> <sub>-3</sub> |        |    |           |    |
| 31               |            |     |        |                                  |        |    | 1050 ± 50 |    |
| 52               |            |     |        |                                  |        |    |           |    |

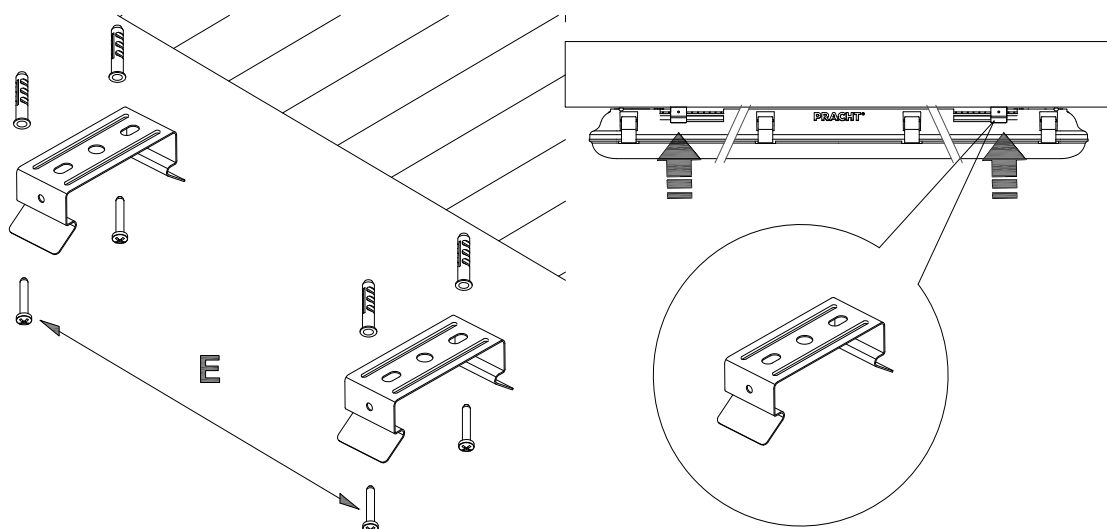
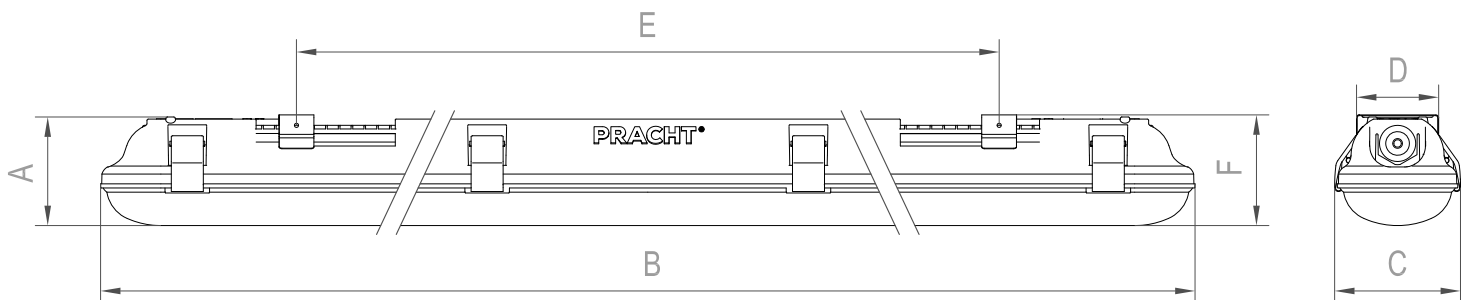
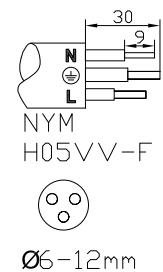

PRACHT.COM / +49 6466/9140-0

Art.-Nr. 0709935