

Datasheet

LINE GRAZER®

Design by REMM



26/11/18 © MCI LIGHT

- Homogenous light for wall washing applications
- High efficiency up to 4800 lm
- 5 beam angles: 9°, 28°, 45°, 10°x 54°, Asym.
- Surfaced or recessed mounted
- Easy serial connection
- Thermal test certificate
- Luz lineal uniforme para bañar paredes
- Alto rendimiento lumínico hasta 4800 lm
- 5 ángulos de apertura: 9°, 28°, 45°, 10°x 54°, Asim.
- Montaje en superficie o empotrado
- Fácil conexión en serie
- Test térmico certificado



<p>Type Modelo</p> <p>300 600 900 1200</p>	<p>N° LEDs</p> <p>48 LEDs/ 1200 mm 36 LEDs/ 1200 mm</p>	<p>Control Control</p> <p>on/off DMX DALI</p> <p>Monocolor</p>
<p>Light colour Color luz</p> <p>WW NW CW SW B RGB RGBW*</p> <p>2800K (± 100 K) 4000K (± 125 K) 6000K (± 400 K) 2800K 4000K 6000K 475 nm White 4000K</p>	<p>Finish Acabado</p> <p>Silver Black White</p> <p>Plata Negro Blanco</p>	
<p>Beam Ángulo</p> <p>9° 28° 45° Elliptical 10°x54° Asym. 16°x60°</p>	<p>Bracket Soporte</p> <p>(95°) High (25°) Low (110°) Side Without (for recessed version)</p> <p>Alto Bajo Lateral Sin (para versión empotrar)</p>	

* Only available in 48 LEDs/1200 mm version.
Sólo disponible en la versión 48 LEDs/1200 mm.

The standard version is delivered with: DMX, side bracket and 10°x 54° beam angle.
La versión estándar se suministra con: DMX, soporte lateral y ángulo de apertura de 10°x 54°.

SPECIFICATIONS
CARACTERÍSTICAS

IP66	IK08	CRI>80	DMX DALI	100-277V AC		AL Housing	Security GLASS Cover	Ta min -20°C -4°F Ta max +50°C +122°F	CE
------	------	--------	-------------	----------------	--	---------------	----------------------------	--	----

Line Grazer® 1200							
Measures	1235 x 111,6 x 72 mm						
Weight	4,5 kg						
48 LEDs (pitch 25 mm)							
Power	55 W						
Color temperatures	2800K	4000K	6000K	Smart White	Blue	RGB	RGBW
Lumens output	9° - 3706 lm 28° - 3547 lm 45° - 3228 lm 10°x 54° - 3467 lm Asym. - 3308 lm	9° - 4240 lm 28° - 4058 lm 45° - 3693 lm 10°x 54° - 3967 lm Asym. - 3785 lm	9° - 4834 lm 28° - 4626 lm 45° - 4210 lm 10°x 54° - 4522 lm Asym. - 4314 lm	9° - 4260 lm 28° - 4077 lm 45° - 3710 lm 10°x 54° - 3985 lm Asym. - 3802 lm	9° - 1298 lm 28° - 1242 lm 45° - 1130 lm 10°x 54° - 1214 lm Asym. - 1158 lm	9° - 2544 lm 28° - 2435 lm 45° - 2216 lm 10°x 54° - 2380 lm Asym. - 2270 lm	9° - 3117 lm 28° - 2983 lm 45° - 2714 lm 10°x 54° - 2916 lm Asym. - 2782 lm
Luminaire efficiency	59 to 67 lm/W	67 to 77 lm/W	76 to 88 lm/W	68 to 78 lm/W	20 to 24 lm/W	40 to 46 lm/W	49 to 57 lm/W
36 LEDs (pitch 33 mm)							
Power	41 W						
Color temperatures	2800K	4000K	6000K	Smart White	Blue	RGB	RGBW
Lumens output	9° - 2780 lm 28° - 2660 lm 45° - 2420 lm 10°x 54° - 2600 lm Asym. - 2480 lm	9° - 3180 lm 28° - 3044 lm 45° - 2770 lm 10°x 54° - 2975 lm Asym. - 2838 lm	9° - 3625 lm 28° - 3470 lm 45° - 3158 lm 10°x 54° - 3392 lm Asym. - 3236 lm	9° - 3194 lm 28° - 3057 lm 45° - 2782 lm 10°x 54° - 2988 lm Asym. - 2851 lm	9° - 974 lm 28° - 932 lm 45° - 848 lm 10°x 54° - 911 lm Asym. - 869 lm	9° - 1908 lm 28° - 1826 lm 45° - 1662 lm 10°x 54° - 1785 lm Asym. - 1703 lm	Not available No disponible
Luminaire efficiency	59 to 68 lm/W	68 to 78 lm/W	77 to 89 lm/W	68 to 78 lm/W	21 to 24 lm/W	41 to 47 lm/W	

Other types on the next page >>>
Otros modelos en página siguiente >>>



Color temperature conform to **ANSI C78.377A**.
Lumens measurement conform to **LM-79-08**.
Lumens maintenance conform to **LM-80-08**.

Temperatura de color según normativa **ANSI C78.377A**.
Medición lumens según normativa **LM-79-08**.
Mantenimiento lumens según normativa **LM-80-08**.

Generalitat of Catalunya Railways,
Barcelona, Spain

SPECIFICATIONS CARACTERÍSTICAS

Line Grazer® 900							
Measures	933 x 111,6 x 72 mm						
Weight	3,5 kg						
36 LEDs [pitch 25 mm]							
Power	43 W						
Color temperatures	2800K	4000K	6000K	Smart White	Blue	RGB	RGBW
Lumens output	9° - 2780 lm 28° - 2660 lm 45° - 2420 lm 10°x 54° - 2600 lm Asym. - 2480 lm	9° - 3180 lm 28° - 3044 lm 45° - 2770 lm 10°x 54° - 2975 lm Asym. - 2838 lm	9° - 3625 lm 28° - 3470 lm 45° - 3158 lm 10°x 54° - 3392 lm Asym. - 3236 lm	9° - 3194 lm 28° - 3057 lm 45° - 2782 lm 10°x 54° - 2988 lm Asym. - 2851 lm	9° - 974 lm 28° - 932 lm 45° - 848 lm 10°x 54° - 911 lm Asym. - 869 lm	9° - 1908 lm 28° - 1826 lm 45° - 1662 lm 10°x 54° - 1785 lm Asym. - 1703 lm	9° - 2337 lm 28° - 2237 lm 45° - 2035 lm 10°x 54° - 2187 lm Asym. - 2086 lm
Luminaire efficiency	56 to 65 lm/W	64 to 74 lm/W	73 to 84 lm/W	65 to 74 lm/W	20 to 23 lm/W	39 to 44 lm/W	48 to 54 lm/W
27 LEDs [pitch 33 mm]							
Power	32 W						
Color temperatures	2800K	4000K	6000K	Smart White	Blue	RGB	RGBW
Lumens output	9° - 2085 lm 28° - 1995 lm 45° - 1816 lm 10°x 54° - 1951 lm Asym. - 1861 lm	9° - 2386 lm 28° - 2283 lm 45° - 2078 lm 10°x 54° - 2232 lm Asym. - 2129 lm	9° - 2720 lm 28° - 2603 lm 45° - 2369 lm 10°x 54° - 2544 lm Asym. - 2427 lm	9° - 2397 lm 28° - 2294 lm 45° - 2088 lm 10°x 54° - 2242 lm Asym. - 2139 lm	9° - 732 lm 28° - 700 lm 45° - 637 lm 10°x 54° - 685 lm Asym. - 653 lm	9° - 1432 lm 28° - 1370 lm 45° - 1247 lm 10°x 54° - 1339 lm Asym. - 1278 lm	Not available No disponible
Luminaire efficiency	59 to 65 lm/W	65 to 75 lm/W	74 to 85 lm/W	65 to 75 lm/W	20 to 21 lm/W	39 to 45 lm/W	
Line Grazer® 600							
Measures	625 x 111,6 x 72 mm						
Weight	2,0 kg						
24 LEDs [pitch 25 mm]							
Power	30 W						
Color temperatures	2800K	4000K	6000K	Smart White	Blue	RGB	RGBW
Lumens output	9° - 1852 lm 28° - 1773 lm 45° - 1613 lm 10°x 54° - 1735 lm Asym. - 1655 lm	9° - 2120 lm 28° - 2029 lm 45° - 1846 lm 10°x 54° - 1983 lm Asym. - 1892 lm	9° - 2417 lm 28° - 2313 lm 45° - 2105 lm 10°x 54° - 2261 lm Asym. - 2157 lm	9° - 2130 lm 28° - 2038 lm 45° - 1855 lm 10°x 54° - 1992 lm Asym. - 1901 lm	9° - 650 lm 28° - 622 lm 45° - 566 lm 10°x 54° - 608 lm Asym. - 580 lm	9° - 1272 lm 28° - 1217 lm 45° - 1108 lm 10°x 54° - 1190 lm Asym. - 1135 lm	9° - 1558 lm 28° - 1491 lm 45° - 1357 lm 10°x 54° - 1458 lm Asym. - 1390 lm
Luminaire efficiency	54 to 62 lm/W	62 to 71 lm/W	70 to 81 lm/W	62 to 72 lm/W	19 to 22 lm/W	37 to 42 lm/W	45 to 52 lm/W
18 LEDs [pitch 33 mm]							
Power	23 W						
Color temperatures	2800K	4000K	6000K	Smart White	Blue	RGB	RGBW
Lumens output	9° - 1390 lm 28° - 1331 lm 45° - 1211 lm 10°x 54° - 1301 lm Asym. - 1241 lm	9° - 1591 lm 28° - 1522 lm 45° - 1386 lm 10°x 54° - 1488 lm Asym. - 1420 lm	9° - 1813 lm 28° - 1735 lm 45° - 1579 lm 10°x 54° - 1695 lm Asym. - 1618 lm	9° - 1598 lm 28° - 1529 lm 45° - 1392 lm 10°x 54° - 1495 lm Asym. - 1426 lm	9° - 487 lm 28° - 466 lm 45° - 424 lm 10°x 54° - 456 lm Asym. - 435 lm	9° - 955 lm 28° - 914 lm 45° - 831 lm 10°x 54° - 893 lm Asym. - 852 lm	Not available No disponible
Luminaire efficiency	53 to 60 lm/W	60 to 69 lm/W	69 to 79 lm/W	61 to 70 lm/W	18 to 21 lm/W	36 to 42 lm/W	
Line Grazer® 300							
Measures	323 x 111,6 x 72 mm						
Weight	1,2 kg						
12 LEDs [pitch 25 mm]							
Power	18 W						
Color temperatures	2800K	4000K	6000K	Smart White	Blue	RGB	RGBW
Lumens output	9° - 927 lm 28° - 887 lm 45° - 810 lm 10°x 54° - 870 lm Asym. - 825 lm	9° - 1060 lm 28° - 1015 lm 45° - 923 lm 10°x 54° - 992 lm Asym. - 946 lm	9° - 1208 lm 28° - 1156 lm 45° - 1052 lm 10°x 54° - 1130 lm Asym. - 1078 lm	9° - 1065 lm 28° - 1115 lm 45° - 927 lm 10°x 54° - 995 lm Asym. - 950 lm	9° - 325 lm 28° - 312 lm 45° - 284 lm 10°x 54° - 305 lm Asym. - 290 lm	9° - 638 lm 28° - 610 lm 45° - 555 lm 10°x 54° - 596 lm Asym. - 569 lm	9° - 779 lm 28° - 746 lm 45° - 675 lm 10°x 54° - 730 lm Asym. - 695 lm
Luminaire efficiency	46 to 52 lm/W	51 to 59 lm/W	58 to 68 lm/W	52 to 59 lm/W	16 to 18 lm/W	31 to 35 lm/W	38 to 43 lm/W
9 LEDs [pitch 33 mm]							
Power	14 W						
Color temperatures	2800K	4000K	6000K	Smart White	Blue	RGB	RGBW
Lumens output	9° - 695 lm 28° - 665 lm 45° - 606 lm 10°x 54° - 651 lm Asym. - 621 lm	9° - 796 lm 28° - 761 lm 45° - 693 lm 10°x 54° - 744 lm Asym. - 710 lm	9° - 907 lm 28° - 868 lm 45° - 790 lm 10°x 54° - 848 lm Asym. - 809 lm	9° - 799 lm 28° - 765 lm 45° - 696 lm 10°x 54° - 748 lm Asym. - 713 lm	9° - 244 lm 28° - 234 lm 45° - 213 lm 10°x 54° - 229 lm Asym. - 218 lm	9° - 477 lm 28° - 457 lm 45° - 416 lm 10°x 54° - 447 lm Asym. - 426 lm	Not available No disponible
Luminaire efficiency	43 to 50 lm/W	50 to 57 lm/W	56 to 65 lm/W	50 to 57 lm/W	15 to 17 lm/W	30 to 34 lm/W	

Color temperature conform to ANSI C78.377A.
Lumens measurement conform to LM-79-08.
Lumens maintenance conform to LM-80-08.

Temperatura de color según normativa ANSI C78.377A.
Medición lumens según normativa LM-79-08.
Mantenimiento lumens según normativa LM-80-08.

LIGHT DISTRIBUTION CURVES
FOTOMETRÍAS

Line Grazer® 1200

48 LEDs **9°**

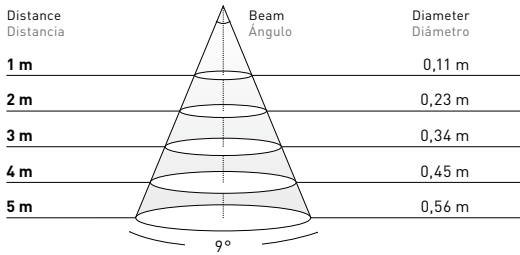

2800K

WARM WHITE
BLANCO CÁLIDO

74.277 lux

18.569 lux

8.253 lux

4.642 lux

2.971 lux

4000K

NEUTRAL WHITE
BLANCO NEUTRO

84.979 lux

21.245 lux

9.442 lux

5.311 lux

3.399 lux

6000K

COOL WHITE
BLANCO FRÍO

96.884 lux

24.221 lux

10.765 lux

6.055 lux

3.875 lux

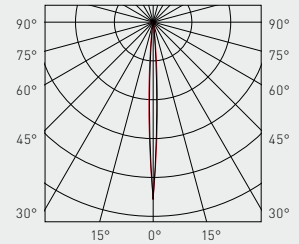

Line Grazer® 1200

48 LEDs **28°**

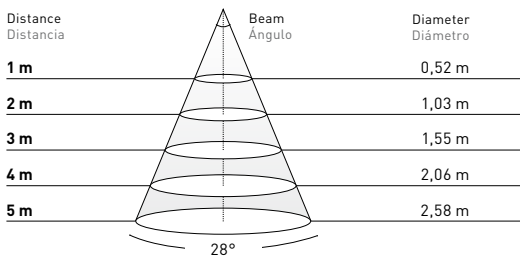

2800K

WARM WHITE
BLANCO CÁLIDO

8.656 lux

2.164 lux

962 lux

541 lux

346 lux

4000K

NEUTRAL WHITE
BLANCO NEUTRO

9.902 lux

2.476 lux

1.100 lux

619 lux

396 lux

6000K

COOL WHITE
BLANCO FRÍO

11.289 lux

2.822 lux

1.254 lux

706 lux

452 lux

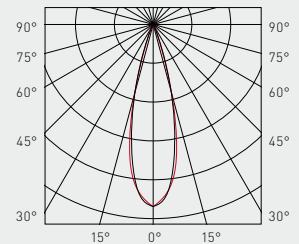

Line Grazer® 1200

48 LEDs **45°**

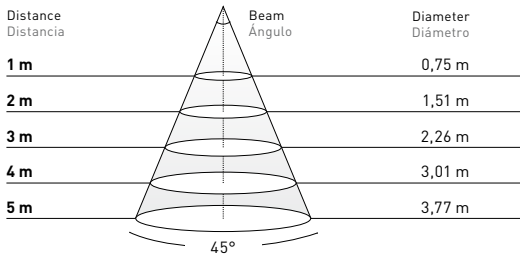

2800K

WARM WHITE
BLANCO CÁLIDO

3.034 lux

759 lux

337 lux

190 lux

121 lux

4000K

NEUTRAL WHITE
BLANCO NEUTRO

3.471 lux

868 lux

386 lux

217 lux

139 lux

6000K

COOL WHITE
BLANCO FRÍO

3.957 lux

989 lux

440 lux

247 lux

158 lux

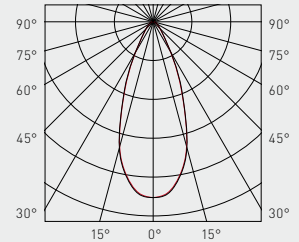

Line Grazer® 1200

48 LEDs **10°x54°**

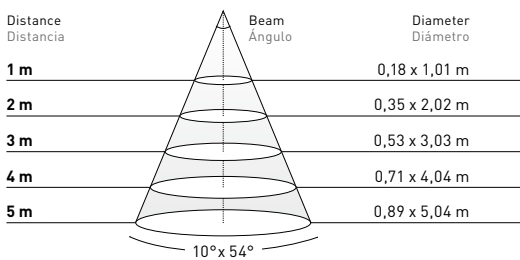

2800K

WARM WHITE
BLANCO CÁLIDO

9.429 lux

2.357 lux

1.048 lux

589 lux

377 lux

4000K

NEUTRAL WHITE
BLANCO NEUTRO

10.789 lux

2.697 lux

1.199 lux

674 lux

432 lux

6000K

COOL WHITE
BLANCO FRÍO

12.298 lux

3.074 lux

1.366 lux

769 lux

492 lux

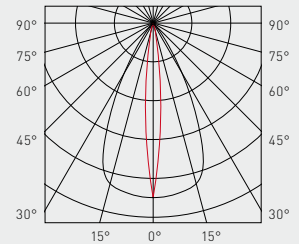

Line Grazer® 1200

48 LEDs **Asym.**

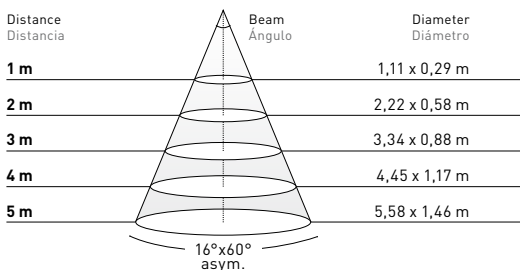

2800K

WARM WHITE
BLANCO CÁLIDO

4.597 lux

1.149 lux

511 lux

287 lux

184 lux

4000K

NEUTRAL WHITE
BLANCO NEUTRO

5.260 lux

1.315 lux

584 lux

329 lux

210 lux

6000K

COOL WHITE
BLANCO FRÍO

5.995 lux

1.499 lux

666 lux

375 lux

240 lux

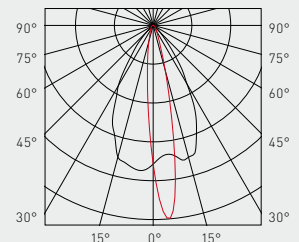

Data calculated with **Line Grazer® (48 LEDs / 1,2m)**.
Lumen measurement complies with **UNE-EN 13032 / IES LM-79-08** testing procedures.
Light distribution curves are available at www.grupo-mci.com.
Due to continuous improvements and innovations, specifications may change without notice.

Datos calculados con **Line Grazer® (48 LEDs / 1,2m)**.
Ensayado bajo las especificaciones de la norma **UNE-EN 13032 / IES LM-79-08**.
Fotometrías disponibles en www.grupo-mci.com.
Debido a las continuas mejoras e innovaciones, las especificaciones pueden cambiar sin previo aviso.



MEASURES MEDIDAS

Line Grazer® 300

Side bracket
Soporte lateral

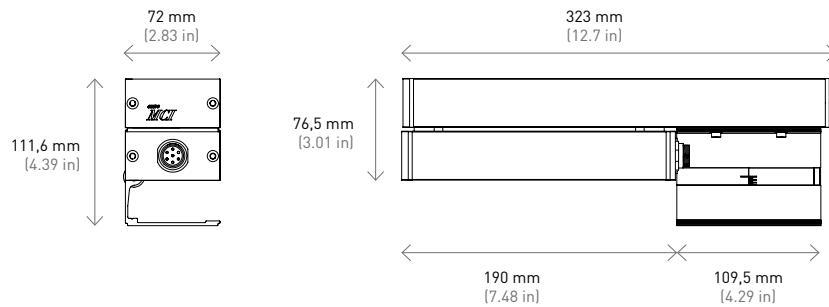

Line Grazer® 600 / 900 / 1200

Side bracket
Soporte lateral

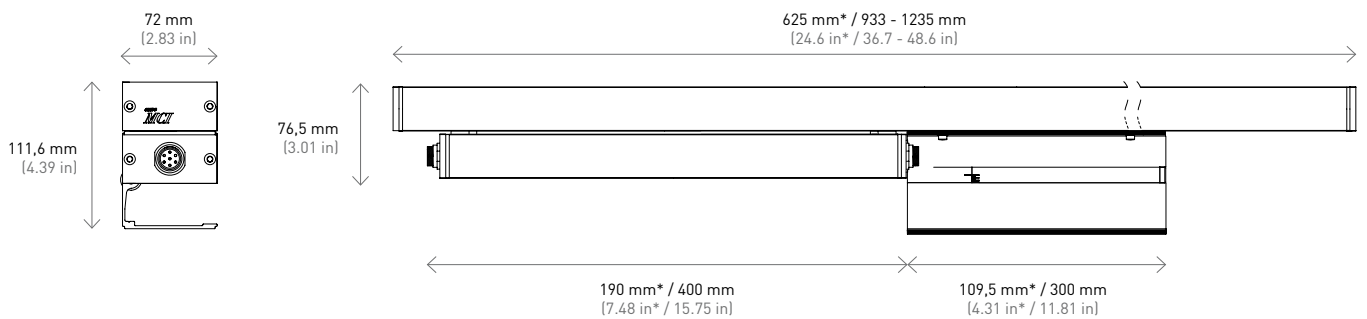

* Measures for Line Grazer® 600.
Medidas para Line Grazer® 600.

ROTATION ROTACIÓN

Side bracket
Soporte lateral

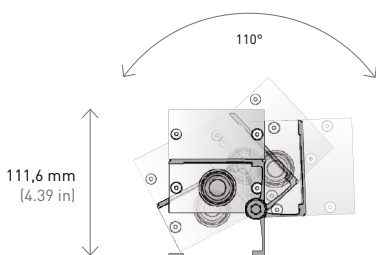

High bracket
Soporte alto

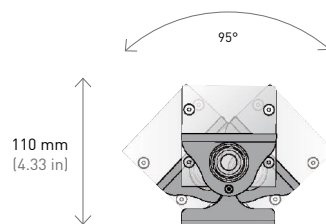

Low bracket
Soporte bajo

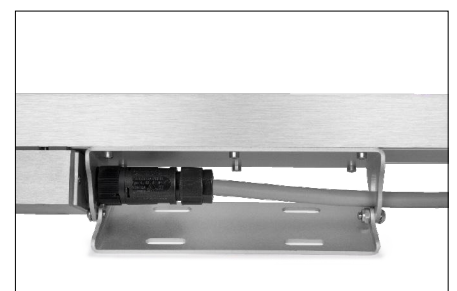
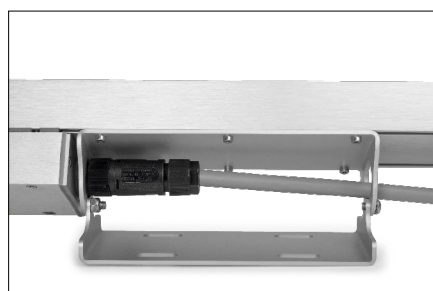
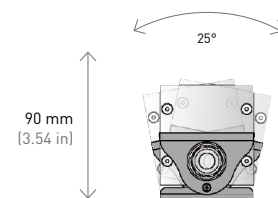

FINISHES
ACABADOS

In order to satisfy all our customers, three different finishes are available: anodized silver, black and white.
Con el fin de satisfacer las necesidades de nuestros clientes, está disponible en tres acabados: anodizado plata, negro y blanco.



Anodized silver.
Anodizado plata.



Black.
Negro.

(RAL 9011)



White.
Blanco.

(RAL 9003)

DETAILS
DETALLES

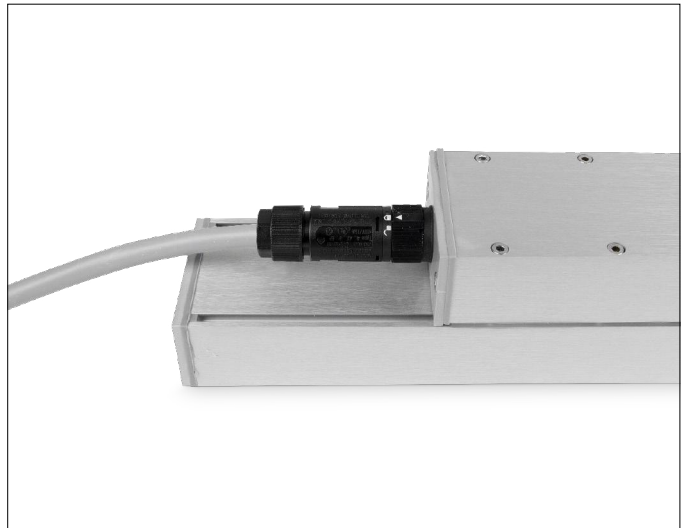
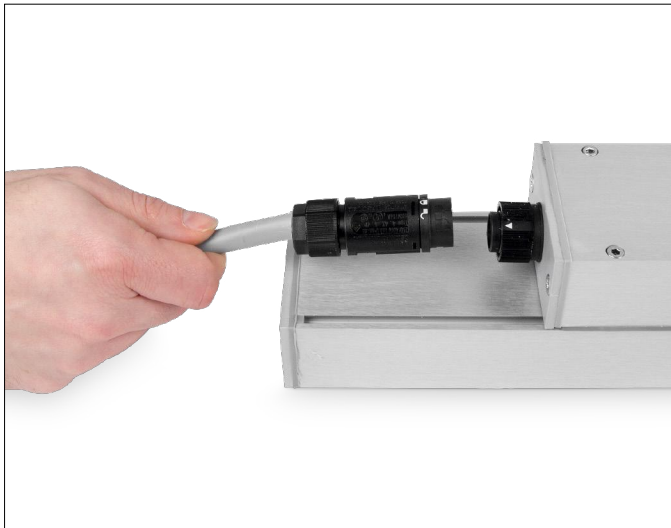

Line Grazer® is supplied with IP68 male-female strain-relief connectors to eliminate accidentally disconnecting the cable from the fixture.
Line Grazer® se suministra con conectores de retención macho-hembra IP68 que evitan desconexiones accidentales.



Molded silicone gasket guarantees IP66.
Junta de silicona moldeada que garantiza un IP66.



Monolithic tempered glass ensures high security protection, stability and hardness.
Cristal de seguridad monolítico templado que garantiza una alta protección, estabilidad y dureza.

MONOCOLOR ON-OFF CONNECTIONS CONEXIONES ON-OFF MONOCOLOR

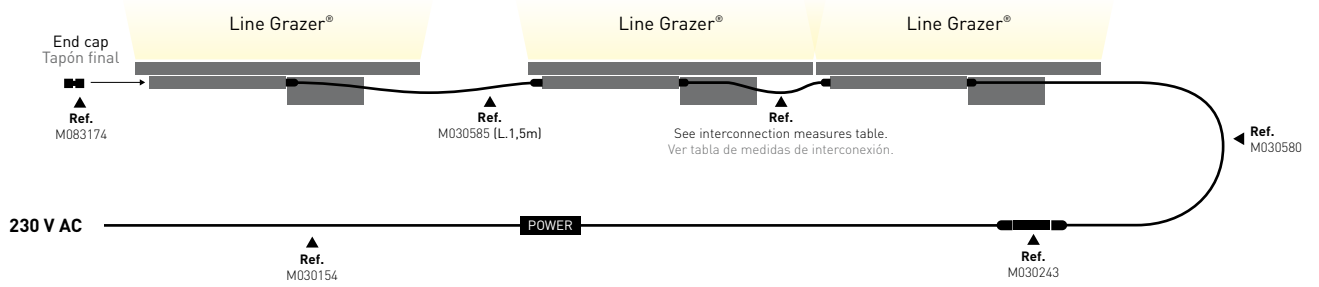

CONNECTIONS CONEXIONES

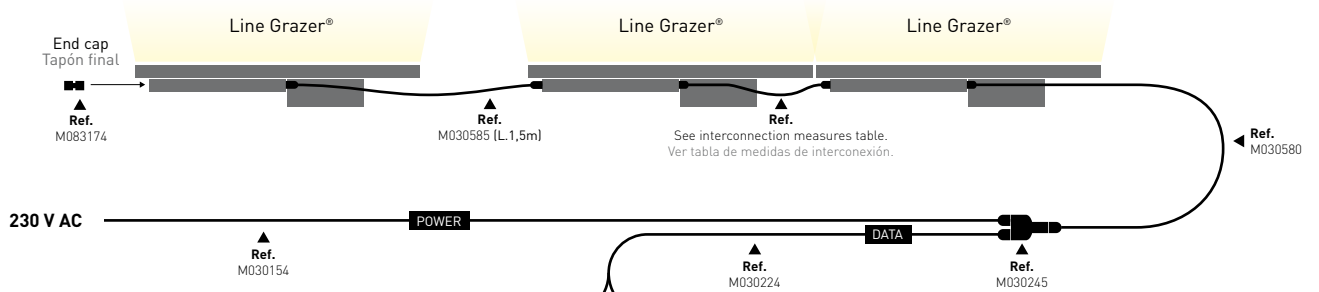

**MORE THAN 15 LINE GRAZER® WITH DMX.
PARA MÁS DE 15 LINE GRAZER® CON DMX.**

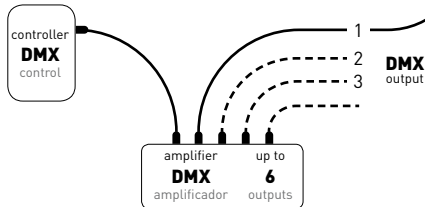

**UP TO 15 LINE GRAZER® WITH DMX.
HASTA 15 LINE GRAZER® CON DMX.**

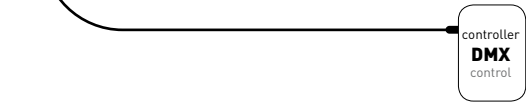

A

**MORE THAN 15 LINE GRAZER® WITH DMX 512-A.
PARA MÁS DE 15 LINE GRAZER® CON DMX 512-A.**

Maximum 15 Line Grazer® per DMX output.
Maximum 100 meters from controller to the amplifier.
Maximum 100 meters from amplifier to last Line Grazer®.

Máximo 15 Line Grazer® por salida DMX.
Máximo 100 metros del controlador al amplificador.
Máximo 100 metros del amplificador al último Line Grazer®.

B

**UP TO 15 LINE GRAZER® WITH DMX 512-A.
HASTA 15 LINE GRAZER® CON DMX 512-A.**

Maximum 15 Line Grazer® per DMX controller.
Maximum 100 meters from controller to last Line Grazer®.
Follow connection diagram type B for DALI installations.

Máximo 15 Line Grazer® por controlador DMX.
Máximo 100 metros del controlador al último Line Grazer®.
Para instalación DALI seguir el conexionado tipo B.

INTERCONNECTION MEASURES TABLE TABLA DE MEDIDAS INTERCONEXIÓN

Line Grazer® 300	Line Grazer® 600	Line Grazer® 900	Line Grazer® 1200	OUT
Line Grazer® 300 only suitable for end of line. Line Grazer® 300 sólo para final de línea.	M030582	M030582	M030582	Line Grazer® 300
	M030583	M030583	M030583	Line Grazer® 600
	M030583	M030583	M030584	Line Grazer® 900
	M030584	M030584	M030584	Line Grazer® 1200

REFERENCES
REFERENCIAS

7501 0 0 1 /80/2K8

COLOR COLOR

- /80/2K8 2800K
- /80/4K 4000K
- /80/6K 6000K
- /2K8-6K Smart white (2800K + 4000K + 6000K)
- /09 Blue Azul
- /11 RGB
- /11-4K RGBW

LENGTH LONGITUD

- 1 300 mm*
- 2 600 mm
- 3 900 mm
- 4 1200 mm

FINISHES ACABADOS

- 0 Silver Plata
- 2 Black Negro
- 3 White Blanco

TYPE MODELO

- 0 48 LEDs / 1,2 m (pitch 25 mm)
- 1 36 LEDs / 1,2 m (pitch 33 mm)

* Line Grazer® 300 only suitable for end of the line.
Line Grazer® 300 sólo para final de línea.

OPTIONS
OPCIONES

The standard version is delivered with:
DMX, side bracket and 10°x 54° beam angle.
La versión estándar se suministra con:
DMX, soporte lateral y ángulo de apertura de 10°x 54°.

CONTROL CONTROL

- on/off**
- DMX 512-A (Standard)
- DALI

BRACKET SOPORTE

- (110°) Side Lateral (Standard)
- (95°) High Alto
- (25°) Low Bajo
- Without Sin (for recessed version)

BEAM ÁNGULO

- 9°
- 10°x 54° (Standard)
- 28°
- 45°
- Asymmetric Asimétrica

** Only available in monocolour version.
Sólo disponible en versión monocolor.

ACCESSORIES REFERENCES
REFERENCIAS ACCESORIOS

1



2



3



4



5



6



M030580	2 m power cable (5 poles-female)	Cable alimentación 2 m (5 polos-hembra)	1
---------	----------------------------------	---	---

See interconnection table (previous page).

Ver tabla de interconexion (página anterior).

M030582	0,4 m extension cable (5 poles)	Cable extensión 0,4 m (5 polos)	
M030583	0,6 m extension cable (5 poles)	Cable extensión 0,6 m (5 polos)	
M030584	0,9 m extension cable (5 poles)	Cable extensión 0,9 m (5 polos)	
M030585	1,5 m extension cable (5 poles)	Cable extensión 1,5 m (5 polos)	
M083174	120 OHM end cap (5 poles-male)	Tapón final 120 OHM (5 polos-macho)	

2

3

Custom assembly for installers.

Para el montaje a medida por el instalador.

M083166	IP68 connector (5 poles-male)	Conector aereo IP68 (5 polos-macho)	
M083173	End cap (male)	Tapón final (macho)	
M083167	IP68 connector (5 poles-female)	Conector aereo IP68 (5 polos-hembra)	
M083172	End cap (female)	Tapón final (hembra)	
M030400/C12	2 x AWG22 + 3 x 1,5 mm² cable (m)	Cable 2 x AWG22 + 3 x 1,5 mm² (m)	

For installation.

Para instalación.

M030243	IP68 "I" connection Ø6-13,5mm Tee Tube (3 poles)	Conexión "I" Ø6-13,5mm IP68 Tee Tube (3 polos)	4
M030245	IP68 "Y" connection Ø6-17mm Tee Tube (5 poles)	Conexión "Y" Ø6-17mm IP68 Tee Tube (5 polos)	5
M030154	3 x 1,5 mm² H07RN-F cable (m)	Cable 3 x 1,5 mm² H07RN-F (m)	
M030224	BELDEN 3105A cable (m)	Cable BELDEN 3105A (m)	
7150203	DMX Addresser Setup	DMX Addresser Setup	

6

RECESSED BOX CAJETÍN DE EMPOTRAR



Easy Plug&Play system for a fast installation in the recessed box. Polyethylene foam protects the recessed box of concrete dilatations.

Unión rápida que permite montar con facilidad la luminaria en la caja de empotrar. La junta de polietileno absorbe las dilataciones del hormigón.

Temporarily immersion protection

A crushed stone surrounding the recessed box is recommended for a correct drainage. Avoid its placing in ground depression.
Incorrect drainage, may cause the loss of warranty.

Para un drenaje correcto se recomienda una capa de grava alrededor de la caja de empotramiento. Evite su colocación en depresiones del terreno.
Un drenaje incorrecto puede significar la pérdida de garantía.

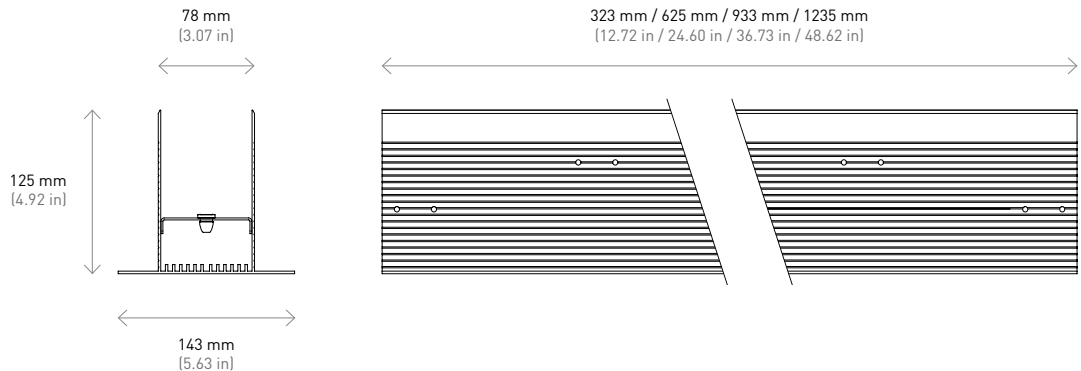

REFERENCES REFERENCIAS

7501094/C12	Recessed box 1200 mm	Cajetín de empotrar 1200 mm
7501093/C12	Recessed box 900 mm	Cajetín de empotrar 900 mm
7501092/C12	Recessed box 600 mm	Cajetín de empotrar 600 mm
7501091/C12	Recessed box 300 mm	Cajetín de empotrar 300 mm



7501095	Fixation kit box	Kit unión cajetín	1
7101196	Centric extraction tool	Útil extracción en línea	2



Sarcelles Church,
France



LINE GRAZER[®] Design by REMM

Datasheet

Due to continuous improvements and innovations, specifications may change without notice.
Debido a continuas mejoras e innovaciones, las especificaciones pueden ser modificadas sin notificación.

26/11/18 © MCI LIGHT



C/ dels Oficis, nº 25
Pol. Ind. el Regàs
08850 · Gavà
Barcelona · SPAIN

T. (+34) 93 630 28 00
F. (+34) 93 630 29 66
M. info@mcilight.com

mcilight.com

by **GRUPO MCI**