

Datasheet

# SQUARE S&M

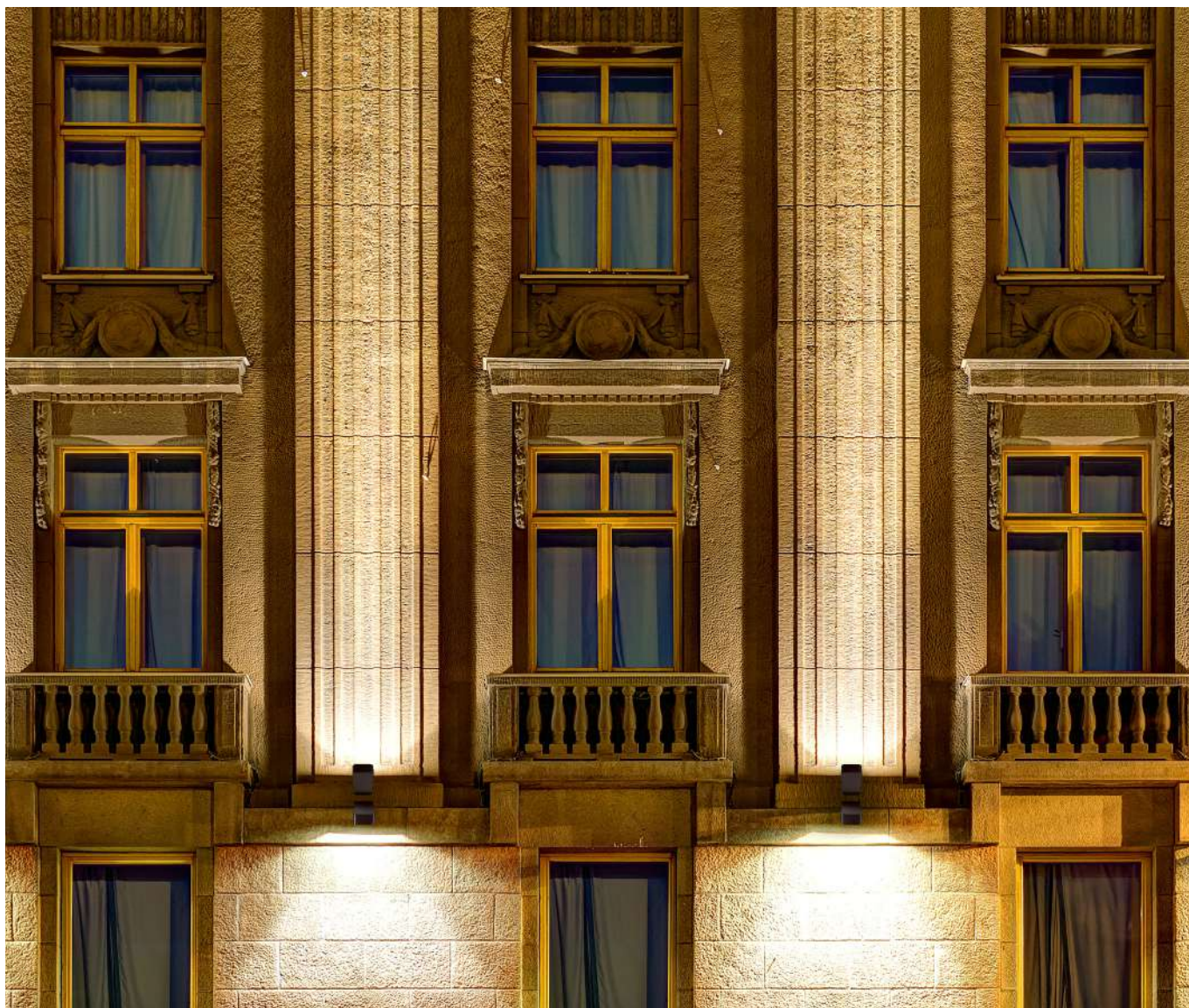

26/11/18 © MCI LIGHT

# SQUARE S&M

- Architectural accent lighting
  - Luminous flux range from 500 lm to 2000 lm
  - Variety of types: Monocolor, RGBW & SW
  - Anti-glare recessed optics
  - 7 beam angles: 9°, 20°, 40°, 48x10°, 10x48°, 55° and 75°
  - Flush cable gland
  - Swivel (360°) and adjustable (180°) projector
  - Integrated driver
  - Easy serial connection
  - Thermal management certificate
- Luz para acentuar la arquitectura
  - Flujos lumínicos de 500 lm a 2000 lm
  - Gran variedad de modelos: Monocolor, RGBW y SW
  - Ópticas antideslumbrantes retranqueadas
  - 7 ángulos de apertura: 9°, 20°, 40°, 48x10°, 10x48°, 55° y 75°
  - Prensaestopas enrasado
  - Proyector rotable (360°) y ajustable (180°)
  - Equipo integrado en la luminaria
  - Fácil conexión en serie
  - Test térmico certificado

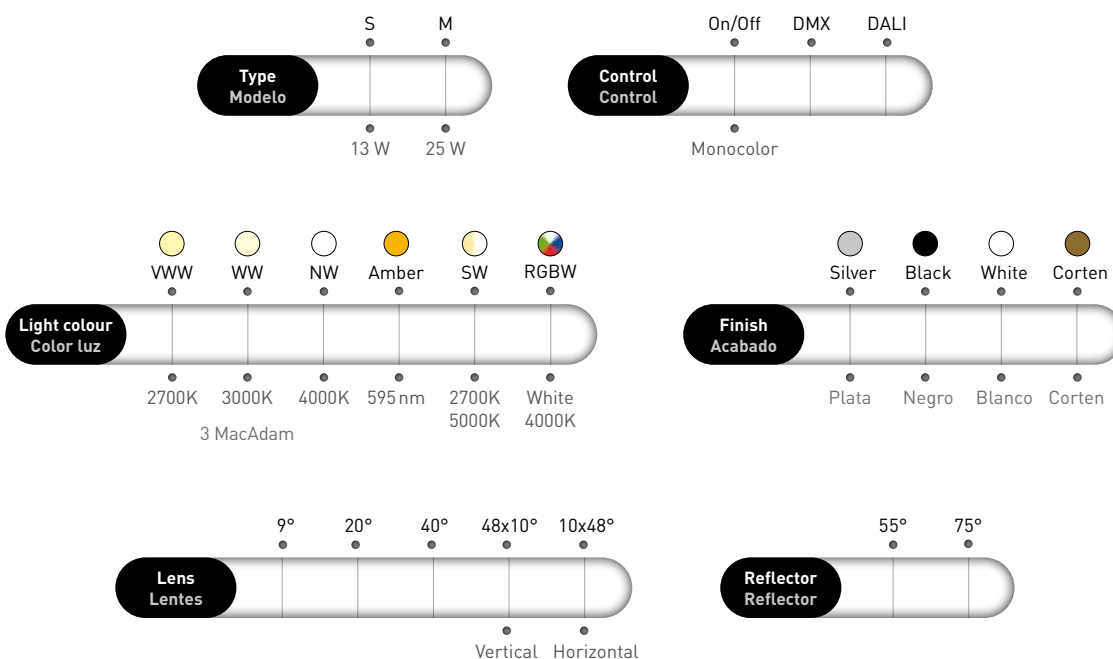

The standard version: 9° lens or 75° reflector.  
Versión estándar: con lente de 9° o reflector de 75°.

The standard version: On/Off control (Monocolor) and DMX control (Smart White & RGBW).  
Versión estándar: con control On/Off (Monocolor) y control DMX (Smart White y RGBW).



**SPECIFICATIONS**  
**CARACTERÍSTICAS**

IP65	CRI>80	100-240V AC		on/off DMX DALI	AL Housing	Security GLASS Cover	Ta min -20°C -4°F Ta max +50°C +122°F	CE
------	--------	----------------	--	-----------------------	---------------	----------------------------	--	----

SQUARE "S"										
Measures / Weight	77 x 194 x 42 mm / 0,550 kg									
Power	13 W / 4 LEDs	13 W / 4 LEDs	13 W / 4 LEDs	15 W / 16 LEDs	15 W / 16 LEDs	15 W / 16 LEDs				
Color temperatures	2700K	3000K	4000K	Amber	Smart White 2700K - 5000K	RGBW				
						Red	Green	Blue	4000K	R+G+B+W
Lumen output	9° - 831 lm 20° - 724 lm 40° - 652 lm 10x48° - 717 lm	9° - 880 lm 20° - 767 lm 40° - 691 lm 10x48° - 760 lm	9° - 978 lm 20° - 852 lm 40° - 768 lm 10x48° - 844 lm	9° - 907 lm 20° - 796 lm 40° - 716 lm 10x48° - 785 lm	9° - 569 lm / 670 lm 20° - 502 lm / 590 lm 40° - 452 lm / 532 lm 10x48° - 493 lm / 580 lm	9° - 135 lm 20° - 119 lm 40° - 107 lm 10x48° - 117 lm	252 lm 221 lm 199 lm 218 lm	91 lm 80 lm 81 lm 77 lm	335 lm 295 lm 266 lm 290 lm	759 lm 668 lm 601 lm 660 lm
Luminaire efficiency	65 lm/W	69 lm/W	77 lm/W	60 lm/W	83 lm/W	52 lm/W				

SQUARE "M"										
Measures / Weight	137 x 194 x 42 mm / 0,850 kg									
Power	25 W / 8 LEDs	25 W / 8 LEDs	25 W / 8 LEDs	27 W / 32 LEDs	27 W / 32 LEDs	27 W / 32 LEDs				
Color temperatures	2700K	3000K	4000K	Amber	Smart White 2700K - 5000K	RGBW				
						Red	Green	Blue	4000K	R+G+B+W
Lumen output	9° - 1662 lm 20° - 1448 lm 40° - 1304 lm 10x48° - 1434 lm	9° - 1760 lm 20° - 1534 lm 40° - 1382 lm 10x48° - 1520 lm	9° - 1956 lm 20° - 1704 lm 40° - 1536 lm 10x48° - 1688 lm	9° - 1814 lm 20° - 1592 lm 40° - 1432 lm 10x48° - 1570 lm	9° - 1138lm/1340lm 20° - 1004lm/1180lm 40° - 904lm/1064lm 10x48° - 986lm/1160lm	9° - 270 lm 20° - 238 lm 40° - 214 lm 10x48° - 234 lm	504 lm 442 lm 398 lm 436 lm	182 lm 160 lm 162 lm 164 lm	670 lm 590 lm 532 lm 580 lm	1518 lm 1336 lm 1202 lm 1320 lm
Luminaire efficiency	66 lm/W	70 lm/W	78 lm/W	65 lm/W	84 lm/W	56 lm/W				



Color temperature conform to ANSI C78.377A.  
Lumens measurement conform to LM-79-08.  
Lumens maintenance conform to LM-80-08.

Temperatura de color según normativa ANSI C78.377A.  
Medición lumens según normativa LM-79-08.  
Mantenimiento lumens según normativa LM-80-08.

# SQUARE S&M

## LIGHT DISTRIBUTION CURVES FOTOMETRÍAS

### Square® S RGBW

15 W 55°

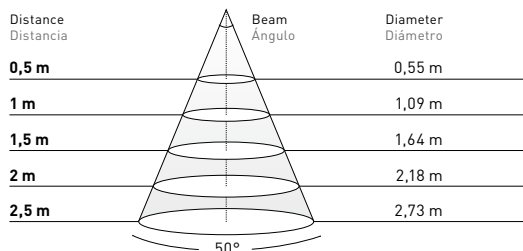

R	G	B	W	R+G+B+W
RED ROJO	GREEN VERDE	BLUE AZUL	WHITE BLANCO	
599 lux	1118 lux	379 lux	1497 lux	3426 lux
150 lux	279 lux	99 lux	374 lux	856 lux
67 lux	124 lux	44 lux	166 lux	381 lux
37 lux	70 lux	25 lux	94 lux	214 lux
24 lux	45 lux	16 lux	60 lux	137 lux

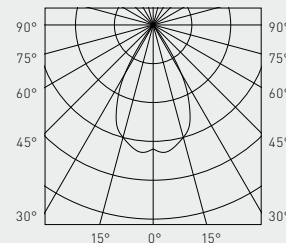

### Square® S

13 W 9°

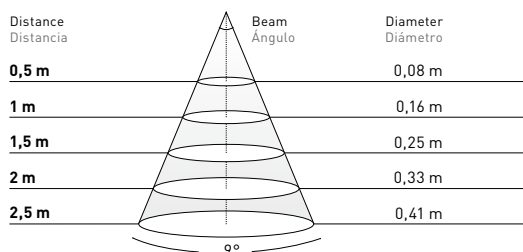

2700K	3000K	4000K
VERY WARM WHITE BLANCO MUY CÁLIDO	WARM WHITE BLANCO CÁLIDO	NEUTRAL WHITE BLANCO NEUTRO
68646 lux	72684 lux	80760 lux
17162 lux	18171 lux	20190 lux
7627 lux	8076 lux	8973 lux
4291 lux	4543 lux	5048 lux
2745 lux	2907 lux	3230 lux

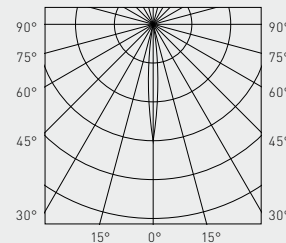

### Square® S

13 W 40°

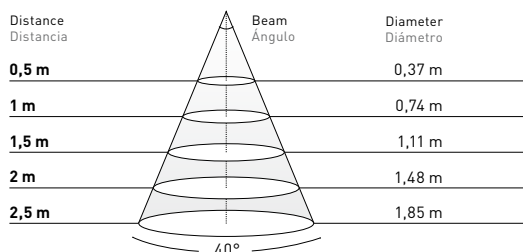

2700K	3000K	4000K
VERY WARM WHITE BLANCO MUY CÁLIDO	WARM WHITE BLANCO CÁLIDO	NEUTRAL WHITE BLANCO NEUTRO
4893 lux	5181 lux	5757 lux
1223 lux	1295 lux	1439 lux
544 lux	576 lux	640 lux
306 lux	324 lux	360 lux
195 lux	207 lux	230 lux

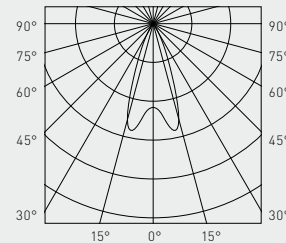

### Square® S

13 W 75°

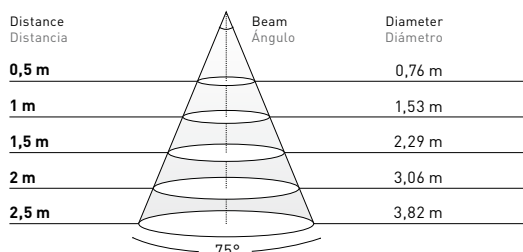

2700K	3000K	4000K
VERY WARM WHITE BLANCO MUY CÁLIDO	WARM WHITE BLANCO CÁLIDO	NEUTRAL WHITE BLANCO NEUTRO
2494 lux	2641 lux	2934 lux
624 lux	661 lux	734 lux
277 lux	293 lux	326 lux
155 lux	165 lux	183 lux
99 lux	105 lux	117 lux

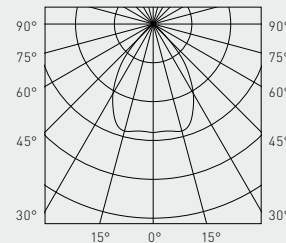

Data calculated with SQUARE S&M.  
Lumen measurement complies with UNE-EN 13032 / IES LM-79-08 testing procedures.  
Light distribution curves are available at [www.grupo-mci.com](http://www.grupo-mci.com).  
Due to continuous improvements and innovations, specifications may change without notice.

Datos calculados con SQUARE S&M.  
Ensayado bajo las especificaciones de la norma UNE-EN 13032 / IES LM-79-08.  
Fotometrías disponibles en [www.grupo-mci.com](http://www.grupo-mci.com).  
Debido a las continuas mejoras e innovaciones, las especificaciones pueden cambiar sin previo aviso.

**MEASURES  
MEDIDAS**

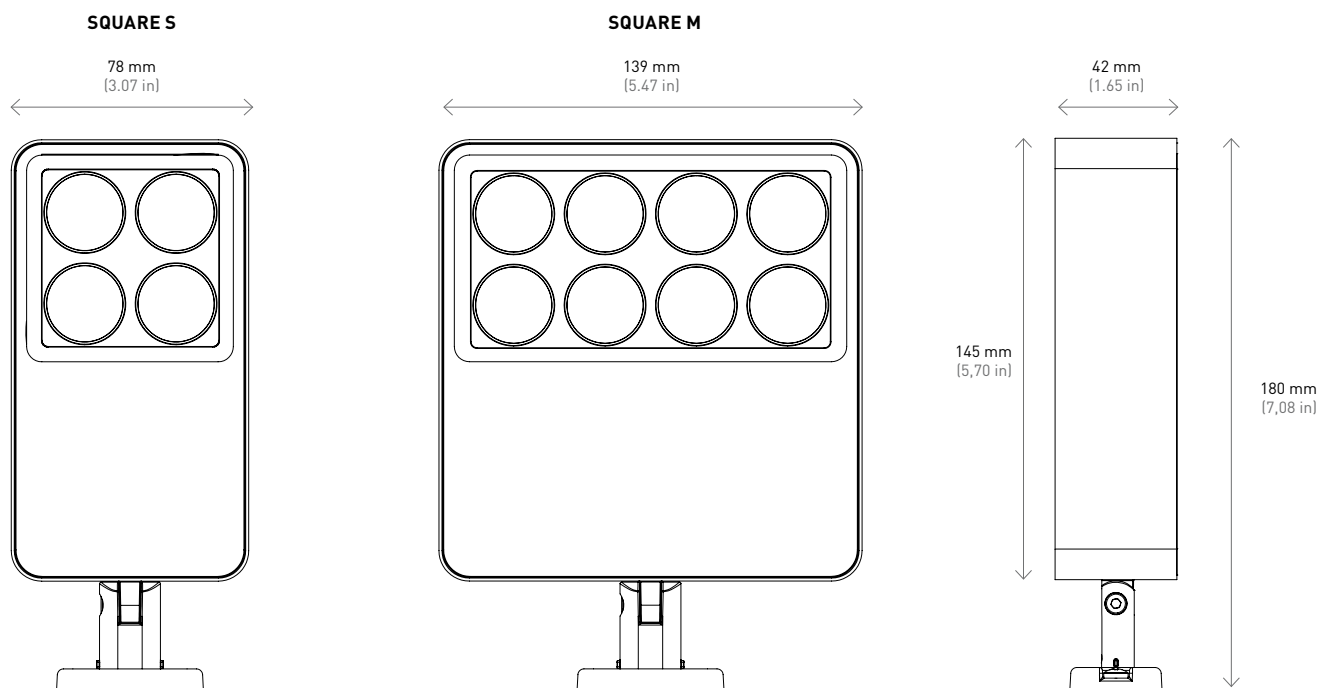

**ROTATION  
ROTACIÓN**

Its elegant and sophisticated design allow us to illuminate to all directions with an exact precision, due to its tool head, movable in horizontal and vertical way. Su diseño elegante y sofisticado nos permite iluminar en todas direcciones con una precisión exacta, gracias a su cabezal orientable en horizontal y vertical.

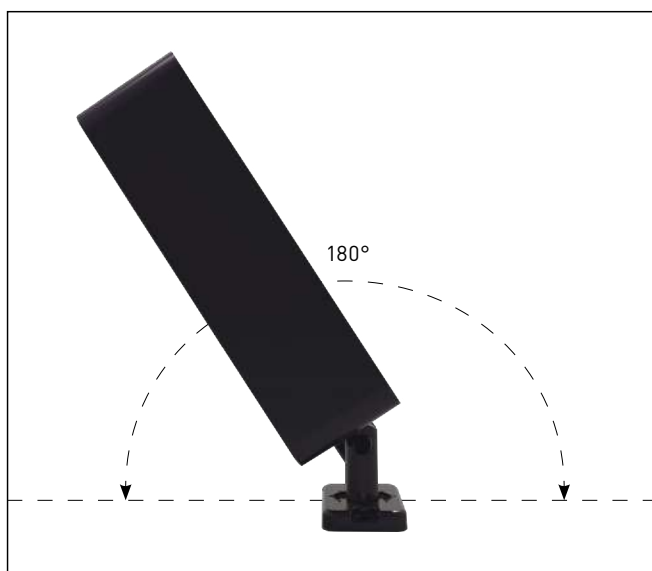

Swivel (360°) and adjustable (180°) projector.  
Proyector rotatable (360°) y ajustable (180°).

# SQUARE S&M

## FINISHES ACABADOS

In order to satisfy all our customers, four different versions are available: silver, black, white and corten.  
Con el fin de satisfacer las necesidades de nuestros clientes, está disponible en cuatro acabados: plata, negro, blanco y corten.



Micro textured silver.  
Plata micro texturizado.



Micro textured black.  
Negro micro texturizado.



Micro textured white.  
Blanco micro texturizado.



Micro textured corten.  
Corten micro texturizado.

## DETAILS DETALLES



Smooth and compact design.  
Diseño liso y compacto.

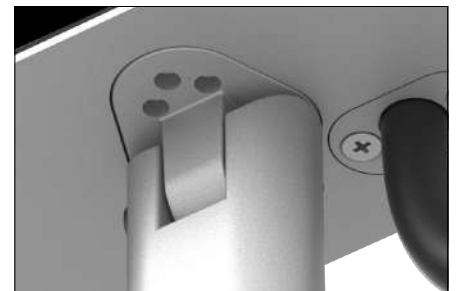

Hidden pressure equalize membrane.  
Membrana oculta de control de presión atmosférica.



Flush cable gland.  
Prensaestopas enrasado.

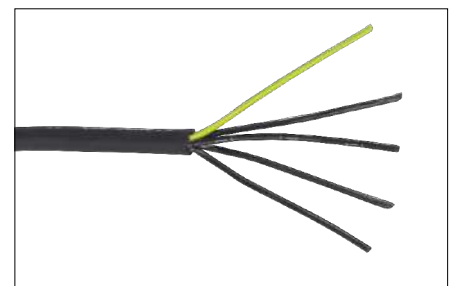

2m wire.  
Cable de 2m.



**DETAILS**  
**DETALLES**

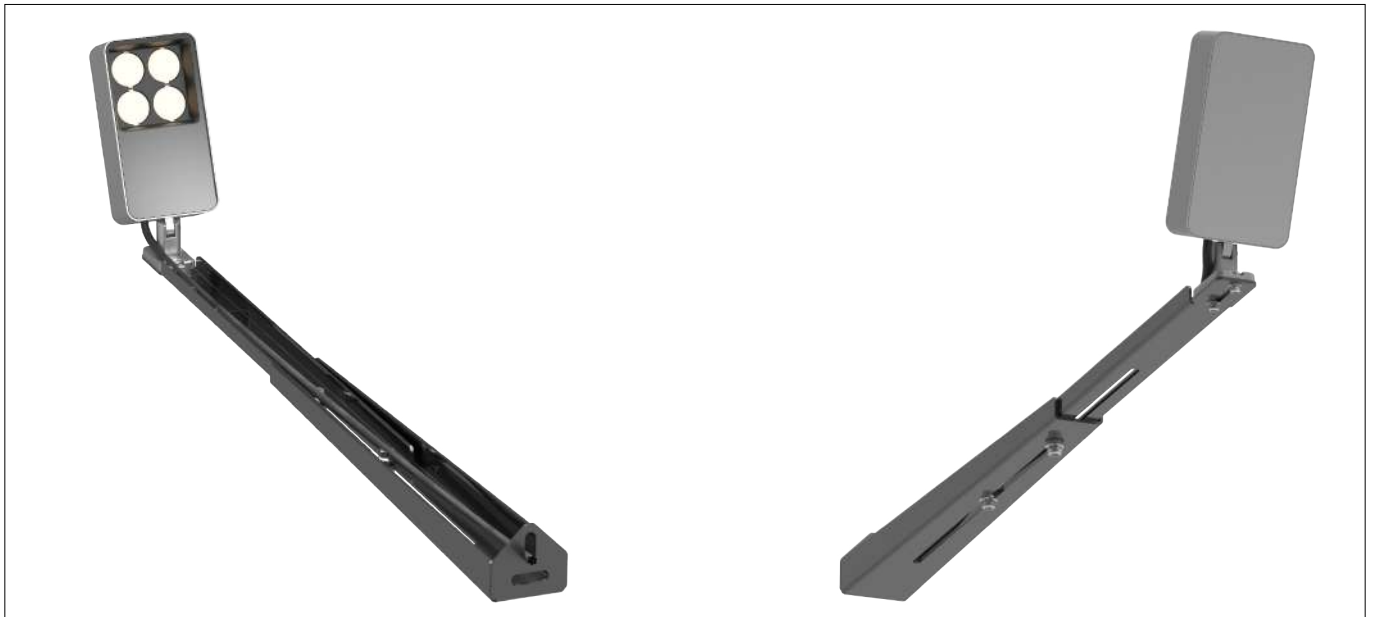

Extensible black arm wall (50-80 cm).  
Brazo pared negro extensible (50-80 cm).



Reflector engineering by Bartenbach:  
55° and 75°  
Reflector diseñado por Bartenbach:  
55° y 75°



Anti-glare recessed optics:  
(9°, 20°, 40°, 48x10° and 10x48°)  
Ópticas antideslumbrantes retranqueadas:  
(9°, 20°, 40°, 48x10° y 10x48°)



Plastic or stainless 316 steel spike.  
Pincho de plástico o inox 316.



Monolithic tempered glass (5mm) ensures high security protection, stability and hardness.  
Cristal de seguridad monolítico templado (5mm) que garantiza una alta protección, estabilidad y dureza.



Black Visor anti-glare for Square S&M.  
Visera antideslumbrante negra para Square S&M.

# SQUARE S&M

## MONOCOLOR ON/OFF CONNECTIONS CONEXIONES ON/OFF MONOCOLOR

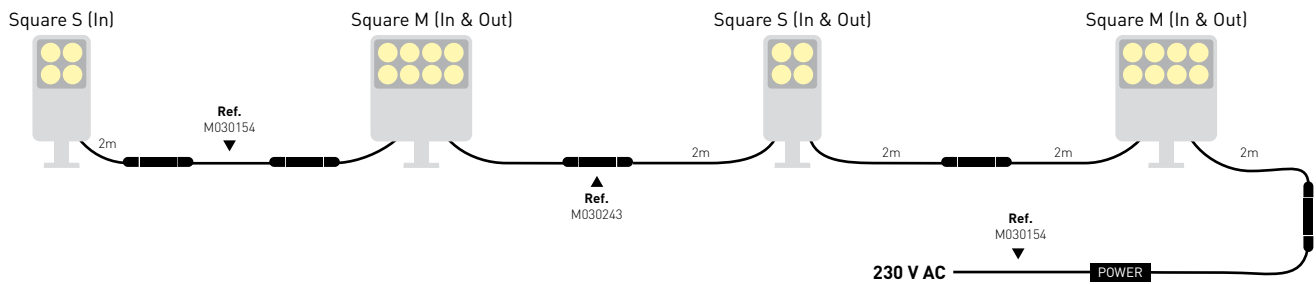
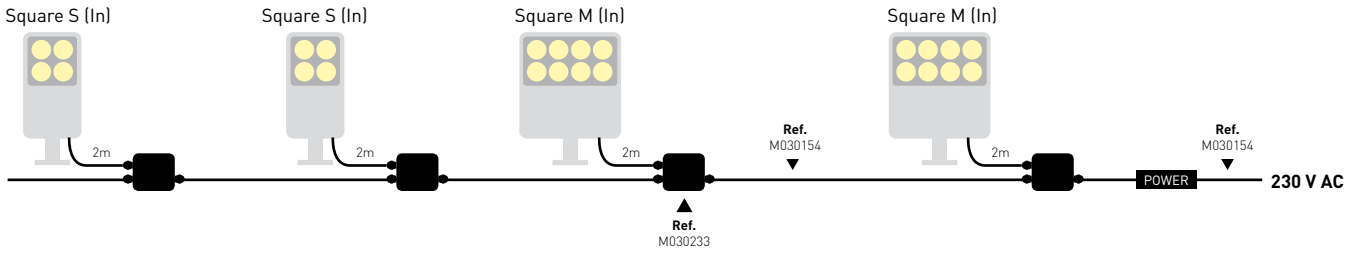

## DMX CONNECTIONS CONEXIONES DMX

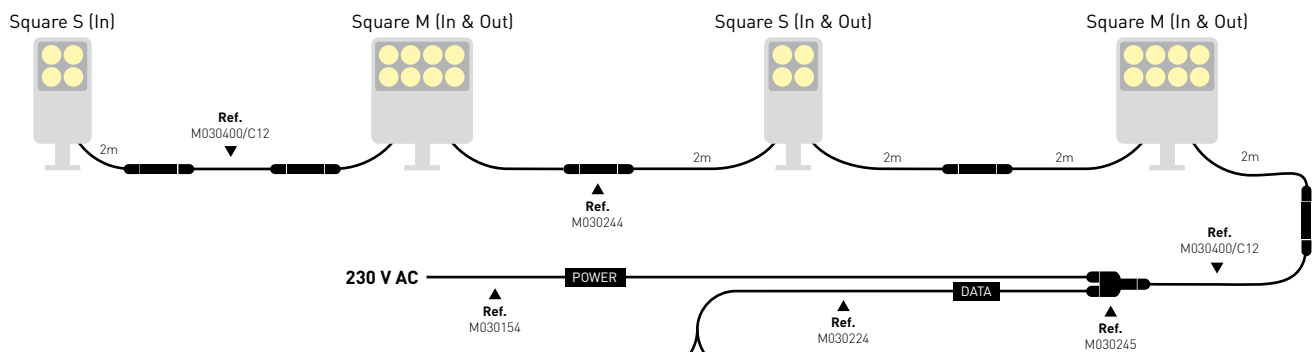

**MORE THAN 15 SQUARE S&M WITH DMX.  
PARA MÁS DE 15 SQUARE S&M CON DMX.**

**UP TO 15 SQUARE S&M WITH DMX.  
HASTA 15 SQUARE S&M CON DMX.**



**A**

**MORE THAN 15 SQUARE S&M WITH DMX 512.  
PARA MÁS DE 15 SQUARE S&M CON DMX 512.**

Maximum 15 SQUARE S&M per DMX output.  
Maximum 100 m from controller to the amplifier.  
Maximum 100 m from amplifier to last SQUARE S&M.

Máximo 15 SQUARE S&M por salida DMX.  
Máximo 100 m del controlador al amplificador.  
Máximo 100 m del amplificador al último SQUARE S&M.

**B**

**UP TO 15 SQUARE S&M WITH DMX 512.  
PARA MENOS DE 15 SQUARE S&M CON DMX 512.**

Maximum 15 SQUARE S&M per DMX controller.  
Maximum 100 m from controller to last SQUARE S&M.  
Follow connection diagram type **B** for DALI installations.

Máximo 15 SQUARE S&M por controlador DMX.  
Máximo 100 m del controlador al último SQUARE S&M.  
Para instalación DALI seguir el conexionado tipo **B**.



REFERENCES  
REFERENCIAS

7502 0 0 0 /80/2K7

COLOUR COLOR

- /80/2K7 2700K
- /80/3K 3000K
- /80/4K 4000K
- /04 Amber Ambar (595nm)
- /2K7-5K Smart White 2700K + 5000K
- /11-4K RGBW (4000K)

BEAM ÓPTICAS

- 0 Lens Lente
- 1 Reflector Reflector

FINISHES ACABADOS

- 0 Texturised silver Plata texturizado
- 2 Texturised black Negro texturizado
- 3 Texturised white Blanco texturizado
- 4 Texturised corten Corten texturizado

TYPE MODELO

- 0 Square S In
- 1 Square S In & Out
- 2 Square M In
- 3 Square M In & Out

OPTIONS  
OPCIONES

The standard version: 9° lens or 75° reflector.  
Versión estándar: con lente de 9° o reflector de 75°.

The standard version: On/Off control (Monocolor) and DMX control (Smart White & RGBW).  
Versión estándar: con control On/Off (Monocolor) y control DMX (Smart White y RGBW).

CONTROL CONTROL

- On/Off (Standard: Monocolor)
- DMX 512-A (Standard: Smart White & RGBW)
- DALI

BEAM (Lens) ÁNGULO (Lente)

- 9° (Standard)
- 20°
- 40°
- 48°x 10° (Vertical)
- 10°x 48° (Horizontal)

BEAM (Reflector) ÁNGULO (Reflector)

- 55°
- 75° (Standard)

ACCESSORIES REFERENCES  
REFERENCIAS ACCESORIOS



7502910	Plastic spike (length: 17,5 cm)	Pincho plástico (longitud: 17,5 cm)	1
7502911	Stainless 316 steel spike (length: 20 cm)	Pincho inox 316 (longitud: 20 cm)	2
7502915/C13	Extensible Black Arm Wall (50-80 cm)	Brazo pared negro extensible (50-80 cm)	3
7502900/C13	Black Visor anti-glare for Square S	Visera antideslumbrante negra para Square S	4
7502901/C13	Black Visor anti-glare for Square M	Visera antideslumbrante negra para Square M	5

For installation On/Off

Para instalación On/Off

M030233	Derivation box	Caja derivación	6
M030243	IP68 "I" connection Ø6-13,5mm Tee Tube (3 poles)	Conexión "I" Ø6-13,5mm IP68 Tee Tube (3 polos)	7
M030154	3 x 1,5 mm² H07RN-F cable (m)	Cable 3 x 1,5 mm² H07RN-F (m)	

For installation DMX

Para instalación DMX

M030244	IP68 "I" connection Ø6-17mm Tee Tube (5 poles)	Conexión "I" Ø6-13,5mm IP68 Tee Tube (5 polos)	8
M030245	IP68 "Y" connection Ø6-17mm Tee Tube (5 poles)	Conexión "Y" Ø6-17mm IP68 Tee Tube (5 polos)	9
M030224	BELDEN 3105A cable (m)	Cable BELDEN 3105A (m)	
7150203	DMX Addresser Setup	DMX Addresser Setup	10
M030154	3 x 1,5 mm² H07RN-F cable (m)	Cable 3 x 1,5 mm² H07RN-F (m)	
M030400/C12	3 x 1,5 mm² + 2 x AWG22 PUR Cable (m)	Cable PUR 3 x 1,5 mm² + 2 x AWG22 (m)	

# SQUARE S&M

## Datasheet



Due to continuous improvements and innovations, specifications may change without notice.  
Debido a continuas mejoras e innovaciones, las especificaciones pueden ser modificadas sin notificación.

26/11/18 © MCI LIGHT



C/ dels Oficis, nº 25  
Pol. Ind. el Regàs  
08850 · Gavà  
Barcelona · SPAIN

T. (+34) 93 630 28 00  
F. (+34) 93 630 29 66  
M. info@mcilight.com

**mcilight.com**

by **GRUPO MCI**