



New Products 2020



Monospace are innovative new area floodlights with puristic design and precise optics. By combining wide beam and asymmetrical reflectors it is possible to choose the ideal light distribution for specific lighting applications. The luminaires are developed for use in urban spaces, pedestrian areas, streets and cycles paths. With neutral and timeless design Monospace can be harmoniously integrated into the landscape architecture.

The luminaires are available with wall mounting brackets or with pole-top fitters. The smooth housing surface is dirt repellent and easy to maintain.

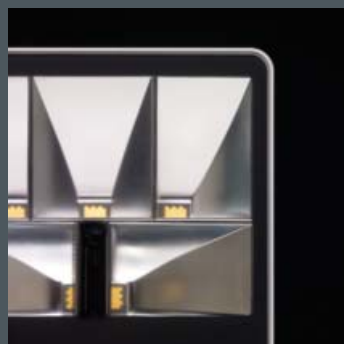
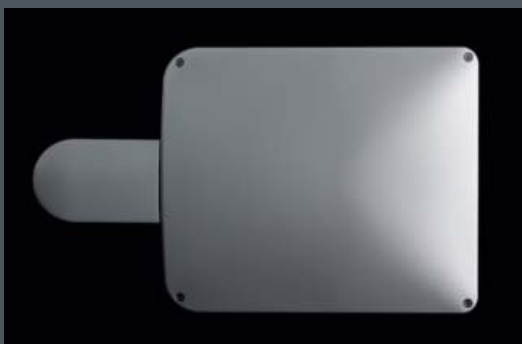





Pole-top luminaires are available complete with one or two floodlights. With a choice of various different light distributions and wattages this configuration can be adapted to a distinct lighting task. The units are pre-assembled for easy installation.

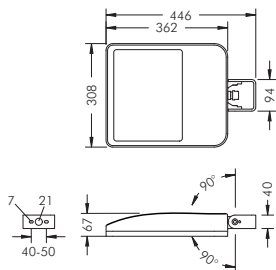

The neutral and functional design of Monospace is compatible with many different architectural environments.



Monospace with wall bracket

With highly efficient LED modules, integral temperature monitoring device, CRI: > 80, Colour tolerance: max. 3 SDCM
 Service life: L80/B20 > 50 000 h
 protection class I, IP65 , IK08
 windage area AW 0.026 m²
 corrosion-resistant die cast aluminium housing AlSi12, polyester powder coated, highly efficient metallized PC reflector, all exterior steel parts are stainless steel, tempered safety glass, silicon gasket, 4 stainless steel screws, front frame with anti-drop device, mounting bracket: 2 drilled holes Ø 7 mm, spacing 40 - 50 mm, 1 centre hole Ø 21 mm, tilt range 180°, M20 cable gland, integral driver

Monospace, asymmetrical beam

Part number*	Colour	Weight	Light source	Luminous flux	Main beam angle γ
8 250 046 049	black	4.5 kg	4 x LED module 11.5 W	5618 lm	58°
8 250 066 049	white		(46 W)		
8 250 056 049	silver grey		warm white (3000 K)		

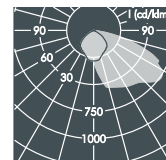
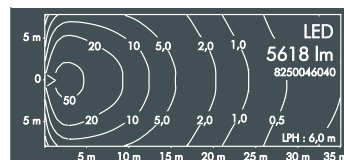

Monospace, asymmetrical beam, High Output

Part number*	Colour	Weight	Light source	Luminous flux	Main beam angle γ
8 251 046 049	black	4.8 kg	4 x LED module 20 W	9041 lm	58°
8 251 066 049	white		(80 W)		
8 251 056 049	silver grey		warm white (3000 K)		

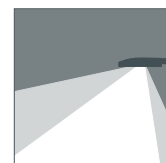
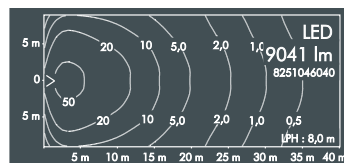

Monospace, asymmetrical wide beam

Part number*	Colour	Weight	Light source	Luminous flux	Beam angle γ (FWHM)	
					C 0 - 180	C 90 - 270
8 250 046 089	black	4.5 kg	5 x LED module 10.8 W	6643 lm	C 0 - 180	C 90 - 270
8 250 066 089	white		(54 W)		60°	138°
8 250 056 089	silver grey		warm white (3000 K)			

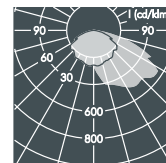
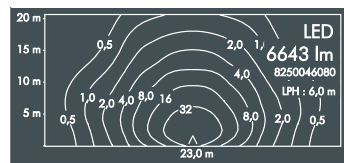

Monospace, asymmetrical wide beam, High Output

Part number*	Colour	Weight	Light source	Luminous flux	Beam angle γ (FWHM)	
					C 0 - 180	C 90 - 270
8 251 046 089	black	4.8 kg	5 x LED module 16 W	9120 lm	C 0 - 180	C 90 - 270
8 251 066 089	white		(80 W)		60°	138°
8 251 056 089	silver grey		warm white (3000 K)			

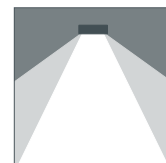
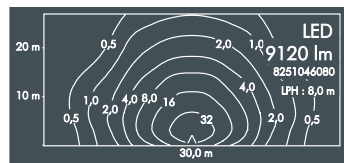

Monospace, lateral wide beam

Part number*	Colour	Weight	Light source	Luminous flux	Beam angle γ (FWHM)	
					C 0 - 180	C 90 - 270
8 250 046 059	black	4.5 kg	4 x LED module 11.5 W	5635 lm	C 0 - 180	C 90 - 270
8 250 066 059	white		(46 W)		33°	148°
8 250 056 059	silver grey		warm white (3000 K)			

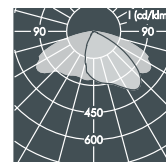
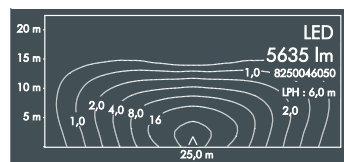

Monospace, lateral wide beam, High Output

Part number*	Colour	Weight	Light source	Luminous flux	Beam angle γ (FWHM)	
					C 0 - 180	C 90 - 270
8 251 046 059	black	4.8 kg	4 x LED module 20 W	9082 lm	C 0 - 180	C 90 - 270
8 251 066 059	white		(80 W)		33°	148°
8 251 056 059	silver grey		warm white (3000 K)			

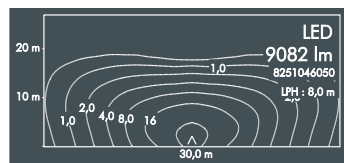

Monospace, Comfort Optic

Part number*	Colour	Weight	Light source	Luminous flux	Beam angle γ (FWHM)	
					C 0 - 180	C 90 - 270
8 250 046 009	black	4.6 kg	1 x LED Prism module 55 W	3971 lm	C 0 - 180	C 90 - 270
8 250 066 009	white		warm white (3000 K)		71°	139°
8 250 056 009	silver grey					

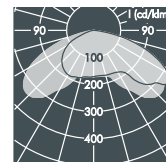
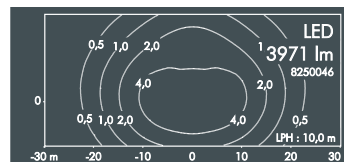

Part number	Description
... .. 5 ...	Luminaire with neutral white colour temperature (4000 K)
... .. 1 ..	Dimmable luminaire (DALI)

LED

Luminaires available in 2700 K and other colour temperatures upon request



Monospace pole-top luminaire, single configuration

With highly efficient LED modules,
integral temperature monitoring device,
CRI: > 80, Colour tolerance: max. 3 SDCM
Service life: L80/B20 > 50 000 h
protection class I, IP65 , IK08
windage area AW 0.038 m²

corrosion-resistant die cast aluminium housing AlSi12,
polyester powder coated,
highly efficient metallized PC reflector,
all exterior steel parts are stainless steel,
tempered safety glass, silicon gasket,
4 stainless steel screws,
front frame with anti-drop device,
with pole top fitter for 1 luminaire for
poles Ø 60/76 mm, 3 M8 grub screws,
tilt range 7°, M20 cable gland,
with 8 m cable H05RN-F3G1,
integral driver

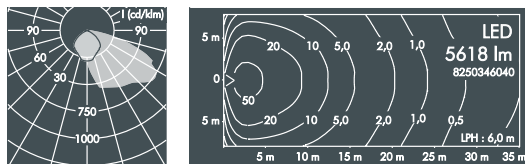
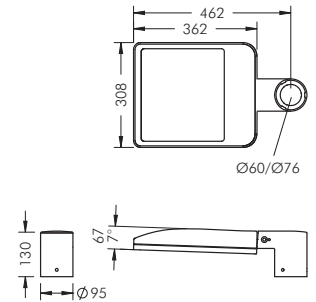

Monospace pole-top luminaire, single configuration, asymmetrical beam

Part number*	Colour	Weight	Light source	Luminous flux	Main beam angle γ
8 250 346 049	black	5.1 kg	4 x LED module 11.5 W (46 W) warm white (3000 K)	5618 lm	58°
8 250 366 049	white				
8 250 356 049	silver grey				

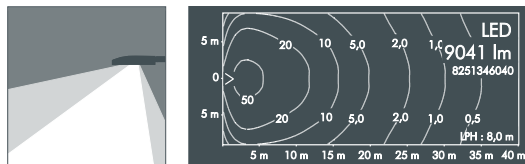

Monospace pole-top luminaire, single configuration, asymmetrical beam, High Output

Part number*	Colour	Weight	Light source	Luminous flux	Main beam angle γ
8 251 346 049	black	5.4 kg	4 x LED module 20 W (80 W) warm white (3000 K)	9041 lm	58°
8 251 366 049	white				
8 251 356 049	silver grey				

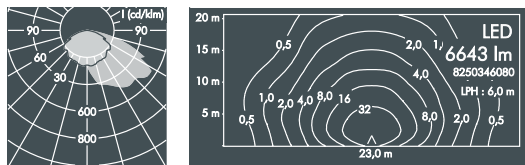

Monospace pole-top luminaire, single configuration, asymmetrical wide beam

Part number*	Colour	Weight	Light source	Luminous flux	Beam angle γ (FWHM)	
8 250 346 089	black	5.1 kg	5 x LED module 10.8 W (54 W) warm white (3000 K)	6643 lm	C 0 - 180	C 90 - 270
8 250 366 089	white				60°	138°
8 250 356 089	silver grey					

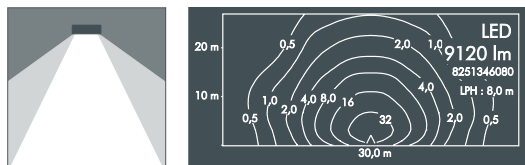

Monospace pole-top luminaire, single configuration, asymmetrical wide beam, High Output

Part number*	Colour	Weight	Light source	Luminous flux	Beam angle γ (FWHM)	
8 251 346 089	black	5.4 kg	5 x LED module 16 W (80 W) warm white (3000 K)	9120 lm	C 0 - 180	C 90 - 270
8 251 366 089	white				60°	138°
8 251 356 089	silver grey					

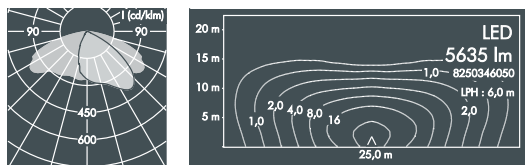

Monospace pole-top luminaire, single configuration, lateral wide beam

Part number*	Colour	Weight	Light source	Luminous flux	Beam angle γ (FWHM)	
8 250 346 059	black	5.1 kg	4 x LED module 11.5 W (46 W) warm white (3000 K)	5635 lm	C 0 - 180	C 90 - 270
8 250 366 059	white				33°	148°
8 250 356 059	silver grey					

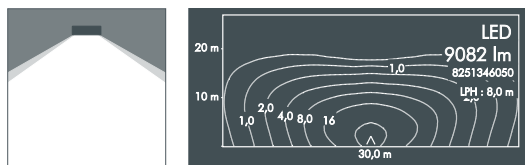

Monospace pole-top luminaire, single configuration, lateral wide beam, High Output

Part number*	Colour	Weight	Light source	Luminous flux	Beam angle γ (FWHM)	
8 251 346 059	black	5.4 kg	4 x LED module 20 W (80 W) warm white (3000 K)	9082 lm	C 0 - 180	C 90 - 270
8 251 366 059	white				33°	148°
8 251 356 059	silver grey					

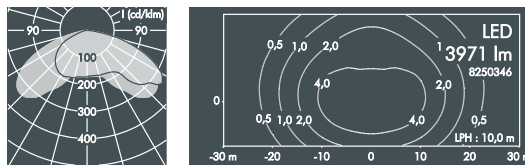

Monospace pole-top luminaire, single configuration, Comfort Optic

Part number*	Colour	Weight	Light source	Luminous flux	Beam angle γ (FWHM)	
8 250 346 009	black	5.2 kg	1 x Prism module 55 W warm white (3000 K)	3971 lm	C 0 - 180	C 90 - 270
8 250 366 009	white				71°	139°
8 250 356 009	silver grey					

LED

Luminaires available in 2700 K and other colour temperatures upon request



Part number	Description
..... 5 ...	Luminaire with neutral white colour temperature (4000 K)
..... 1 ..	Dimmable luminaire (DALI)

*Additional dimming options and Zhaga 18-interface are available upon request.

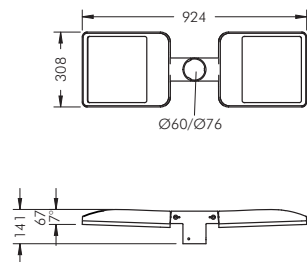

Monospace pole-top luminaire, double configuration

With highly efficient LED modules, integral temperature monitoring device, CRI: > 80, Colour tolerance: max. 3 SDCM
 Service life: L80/B20 > 50 000 h
 protection class I, IP65 , IK08
 windage area AW 0.063 m²
 corrosion-resistant die cast aluminium housing AlSi12, polyester powder coated,
 highly efficient metallized PC reflector, all exterior steel parts are stainless steel, tempered safety glass, silicon gasket, 4 stainless steel screws,
 front frame with anti-drop device, with pole top fitter for 2 luminaires for poles Ø 60/76 mm, 3 M8 grub screws, tilt range 7°, M20 cable gland, with 2 x 8 m cable H05RN-F3G1, integral driver

Monospace pole-top luminaire, double configuration, asymmetrical beam

Part number*	Colour	Weight	Light source	Luminous flux	Beam angle γ (FWHM)
8 250 446 049	black	9.7 kg	8 x LED module 11.5 W (92 W) warm white (3000 K)	11236 lm	58°
8 250 466 049	white				
8 250 456 049	silver grey				

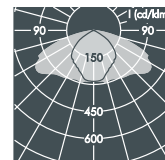
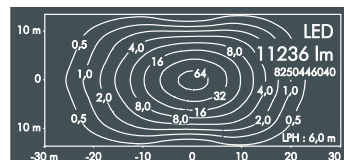

Monospace pole-top luminaire, double configuration, asymmetrical beam, High Output

Part number*	Colour	Weight	Light source	Luminous flux	Beam angle γ (FWHM)
8 251 446 049	black	10.3 kg	8 x LED module 20 W (160 W) warm white (3000 K)	18082 lm	58°
8 251 466 049	white				
8 251 456 049	silver grey				

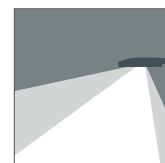
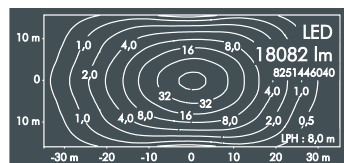

Monospace pole-top luminaire, double configuration, asymmetrical wide beam

Part number*	Colour	Weight	Light source	Luminous flux	Beam angle γ (FWHM)	
8 250 446 089	black	9.7 kg	10 x LED module 10.8 W (108 W) warm white (3000 K)	13286 lm	C 0 – 180	C 90 – 270
8 250 466 089	white				60°	138°
8 250 456 089	silver grey					

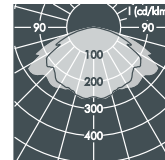
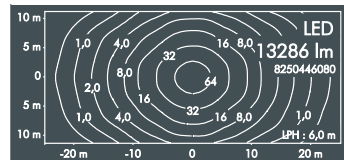

Monospace pole-top luminaire, double configuration, asymmetrical wide beam, High Output

Part number*	Colour	Weight	Light source	Luminous flux	Beam angle γ (FWHM)	
8 251 446 089	black	10.3 kg	10 x LED module 16 W (160 W) warm white (3000 K)	18240 lm	C 0 – 180	C 90 – 270
8 251 466 089	white				60°	138°
8 251 456 089	silver grey					

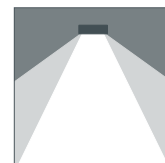
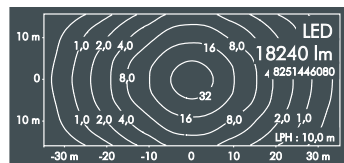

Monospace pole-top luminaire, double configuration, lateral wide beam

Part number*	Colour	Weight	Light source	Luminous flux	Beam angle γ (FWHM)	
8 250 446 059	black	9.7 kg	8 x LED module 11.5 W (92 W) warm white (3000 K)	11270 lm	C 0 – 180	C 90 – 270
8 250 466 059	white				33°	148°
8 250 456 059	silver grey					

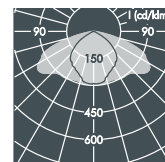
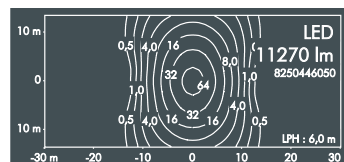

Monospace pole-top luminaire, double configuration, lateral wide beam, High Output

Part number*	Colour	Weight	Light source	Luminous flux	Beam angle γ (FWHM)	
8 251 446 059	black	10.3 kg	8 x LED module 20 W (160 W) warm white (3000 K)	18164 lm	C 0 – 180	C 90 – 270
8 251 466 059	white				33°	148°
8 251 456 059	silver grey					

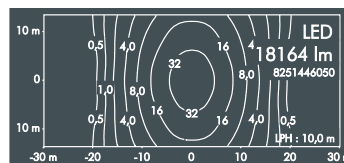

Monospace pole-top luminaire, double configuration, Comfort Optic

Part number*	Colour	Weight	Light source	Luminous flux	Beam angle γ (FWHM)	
8 250 446 009	black	9.8 kg	2 x LED Prism module 55 W (110 W) warm white (3000 K)	7942 lm	C 0 – 180	C 90 – 270
8 250 466 009	white				71°	139°
8 250 456 009	silver grey					

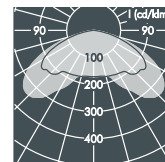
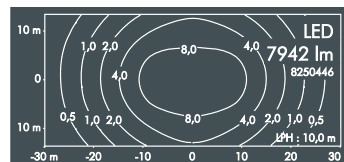

Part number	Description
... . 5 ...	Luminaire with neutral white colour temperature (4000 K)
... . 1 ..	Dimmable luminaire (DALI)

LED

Luminaires available in 2700 K and other colour temperatures upon request



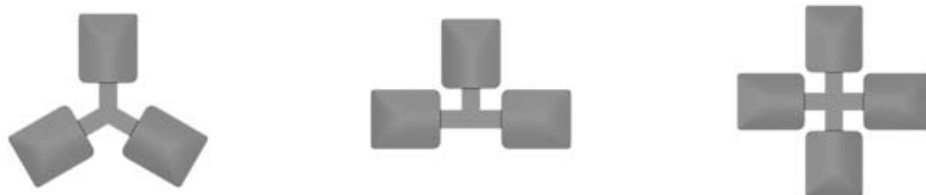

In addition to pole-top luminaires with single or double configurations custom-made versions with three or four luminaires are available upon request.

Illumination examples for Monospace pole-top luminaires with different light distributions

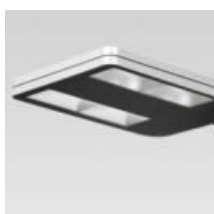

The asymmetrical beam optic with forward throw light distribution achieves high lux levels over a long distance in front of the luminaire.



With the asymmetrical wide beam optic uniform illumination on an area in front of and to both sides of the luminaire can be achieved.



The lateral wide beam optic directs light onto paths, streets and driveways and makes large luminaire spacings possible.

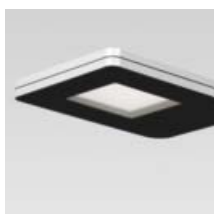

The Comfort Optic creates an even light distribution in front of and on both sides of the luminaire with optimal glare control.



Monoflood is a new luminaire series with precise beam control and minimalist design. The floodlights are available in four sizes and wattages. With a wide choice of different reflectors and lens optics they can be used for various different illumination tasks. The scope of applications includes uniform area lighting and accent lighting of façade details. The large variety of different light distributions makes Monoflood a versatile tool for architectural lighting.

Symmetrical and asymmetrical reflectors are available for uniform illumination.
Narrow beam optics achieve high lux levels over long distances – monochrome or with RGBW LEDs.

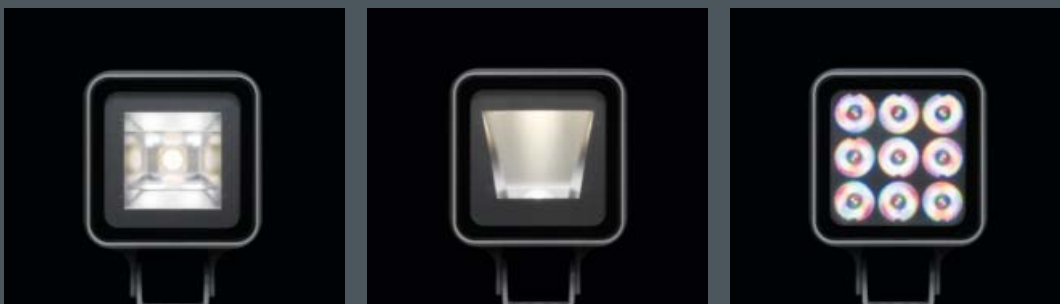

Monoflood pole luminaires are equipped with a tilt-and-turn fixing system. Luminaires with different sizes and light distributions can be combined. This makes customized configurations for specific lighting tasks possible.



The series offers compact floodlights for accent lighting on buildings and high performance floodlights for the illumination of tall objects.



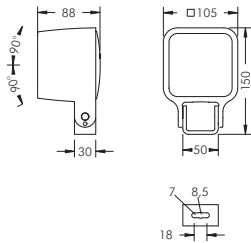

Monoflood 1 with mounting bracket reflector optic

With a high performance LED module (Zhaga), integral temperature monitoring device, CRI: > 80, Colour tolerance: max. 3 SDCM Service life: L90/B10 > 50 000 h protection class I, IP65 , IK08 windage area AW 0.01 m² corrosion-resistant die cast aluminium housing AlSi12, polyester powder coated, highly efficient aluminium reflector, all exterior steel parts are stainless steel, tempered safety glass, silicon gasket, closure with 4 stainless steel screws, mounting bracket: 1 elongated hole Ø 7 mm, spacing 18 mm, 1 centre hole Ø 8,5 mm, tilt range 180°, M16 cable gland, integral driver (AC/DC)

Monoflood 1, axially symmetrical wide beam

Part number	Colour	Weight	Light source	Luminous flux	Beam angle γ (FWHM)	
8 201 046 059	black	1.1 kg	1 x LED module 14 W warm white (3000 K)	1437 lm	C 0 – 180	C 90 – 270
8 201 066 059	white				85°	83°
8 201 056 059	silver grey					

Part number	Colour	Weight	Light source	Luminous flux	Beam angle γ (FWHM)	
8 201 045 059	black	1.1 kg	1 x LED module 14 W neutral white (4000 K)	1509 lm	C 0 – 180	C 90 – 270
8 201 065 059	white				85°	83°
8 201 055 059	silver grey					

Part number	Description
. 1..	Dimmable luminaire (DALI)

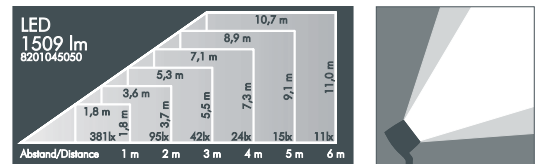
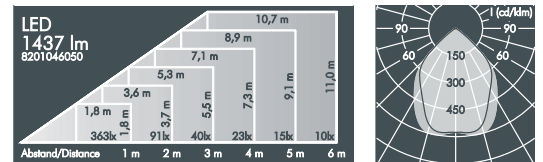

LED

Luminaires available in 2700 K and other colour temperatures upon request



Monoflood 1 with mounting bracket lens optics

With 4 x high performance LEDs,
integral temperature monitoring device,
CRI: > 80, Colour tolerance: max. 2 SDCM
Service life: L90/B10 > 50 000 h
protection class I, IP65 , IK08
windage area AW 0.01 m²
corrosion-resistant die cast aluminium housing AISi12,
polyester powder coated,
precise PMMA optics,
all exterior steel parts are stainless steel,
tempered safety glass, silicon gasket,
closure with 4 stainless steel screws,
mounting bracket: 1 elongated hole \varnothing 7 mm,
spacing 18 mm, 1 centre hole \varnothing 8.5 mm,
tilt range 180°, M16 cable gland,
integral driver (AC/DC)

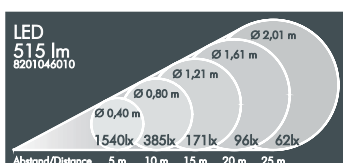
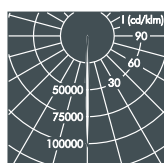
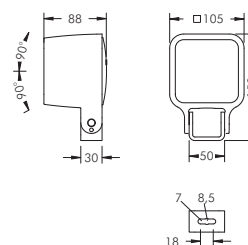

Monoflood 1, narrow beam

Part number	Colour	Weight	Light source	Luminous flux	Beam angle γ (FWHM)
8 201 046 019	black	1.2 kg	4 x LED 2.5 W (10 W) warm white (3000 K)	515 lm	4°
8 201 066 019	white				
8 201 056 019	silver grey				

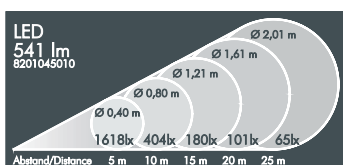
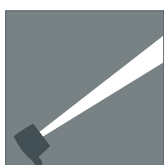

Part number	Colour	Weight	Light source	Luminous flux	Beam angle γ (FWHM)
8 201 045 019	black	1.2 kg	4 x LED 2.5 W (10 W) neutral white (4000 K)	541 lm	4°
8 201 065 019	white				
8 201 055 019	silver grey				

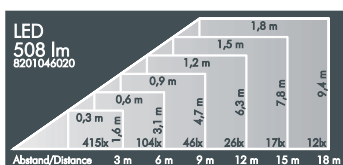
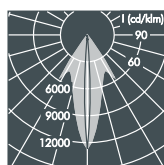

Monoflood 1, linear beam spread, vertical

Part number	Colour	Weight	Light source	Luminous flux	Beam angle γ (FWHM)
8 201 046 029	black	1.2 kg	4 x LED 2.5 W (10 W) warm white (3000 K)	508 lm	C 0 – 180
8 201 066 029	white				29°
8 201 056 029	silver grey				6°

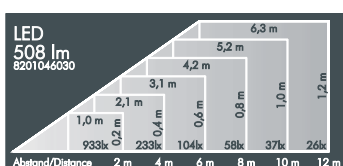

Monoflood 1, linear beam spread, horizontal

Part number	Colour	Weight	Light source	Luminous flux	Beam angle γ (FWHM)
8 201 046 039	black	1.2 kg	4 x LED 2.5 W (10 W) warm white (3000 K)	508 lm	C 0 – 180
8 201 066 039	white				6°
8 201 056 039	silver grey				29°

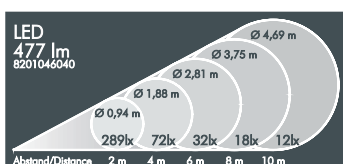
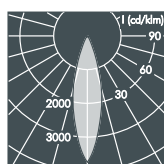

Monoflood 1, medium wide beam

Part number	Colour	Weight	Light source	Luminous flux	Beam angle γ (FWHM)
8 201 046 049	black	1.2 kg	4 x LED 2.5 W (10 W) warm white (3000 K)	477 lm	27°
8 201 066 049	white				
8 201 056 049	silver grey				

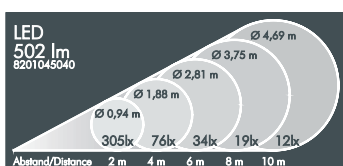

Part number	Colour	Weight	Light source	Luminous flux	Beam angle γ (FWHM)
8 201 045 049	black	1.2 kg	4 x LED 2.5 W (10 W) neutral white (4000 K)	502 lm	27°
8 201 065 049	white				
8 201 055 049	silver grey				

Part number	Description
... .. 5 ...	Luminaire with neutral white colour temperature (4000 K)
... .. 1 ..	Dimmable luminaire (DALI)

LED

Luminaires available in 2700 K and other colour temperatures upon request



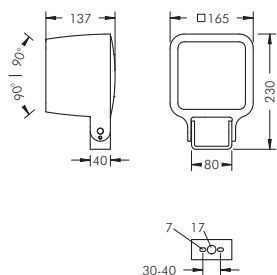

Monoflood 2 with mounting bracket reflector optic

With a high performance LED module (Zhaga), integral temperature monitoring device, CRI: > 85, Colour tolerance: max. 2 SDCM Service life: L90/B10 > 50 000 h protection class I, IP65 \diamond \triangle \triangle , IK08 windage area AW 0.024 m² corrosion-resistant die cast aluminium housing AlSi12, polyester powder coated, highly efficient aluminium reflector, all exterior steel parts are stainless steel, tempered safety glass, silicon gasket, closure with 4 stainless steel screws, mounting bracket: 2 drilled holes \varnothing 7 mm, spacing 30 - 40 mm, 1 centre hole \varnothing 17 mm, tilt range 180°, M16 cable gland, integral driver (AC/DC)

Monoflood 2, axially symmetrical wide beam

Part number	Colour	Weight	Light source	Luminous flux	Beam angle γ (FWHM)	
8 202 046 059	black	2.8 kg	1 x LED module 27 W	3009 lm	C 0 – 180	C 90 – 270
8 202 066 059	white		warm white (3000 K)		88°	89°
8 202 056 059	silver grey					

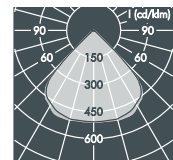
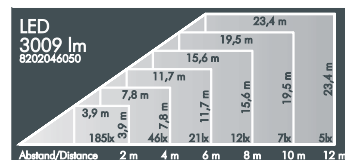

Part number	Colour	Weight	Light source	Luminous flux	Beam angle γ (FWHM)	
8 202 045 059	black	2.8 kg	1 x LED module 27 W	3159 lm	C 0 – 180	C 90 – 270
8 202 065 059	white		neutral white (4000 K)		88°	89°
8 202 055 059	silver grey					

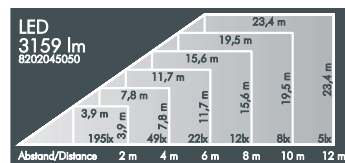

Monoflood 2, axially symmetrical narrow beam

Part number	Colour	Weight	Light source	Luminous flux	Beam angle γ (FWHM)	
8 202 046 069	black	2.8 kg	1 x LED module 27 W	2884 lm	C 0 – 180	C 90 – 270
8 202 066 069	white		warm white (3000 K)		55°	86°
8 202 056 069	silver grey					

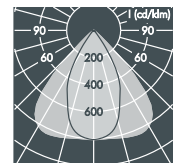
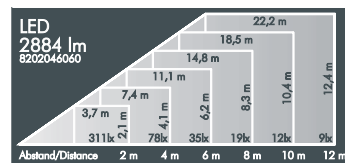

Part number	Colour	Weight	Light source	Luminous flux	Beam angle γ (FWHM)	
8 202 045 069	black	2.8 kg	1 x LED module 27 W	3028 lm	C 0 – 180	C 90 – 270
8 202 065 069	white		neutral white (4000 K)		55°	86°
8 202 055 069	silver grey					

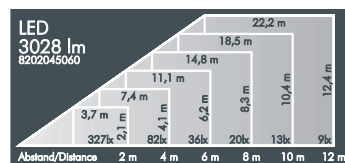

Monoflood 2, asymmetrical beam

Part number	Colour	Weight	Light source	Luminous flux	Main beam angle γ
8 202 046 099	black	2.8 kg	1 x LED module 27 W	2774 lm	53°
8 202 066 099	white		warm white (3000 K)		
8 202 056 099	silver grey				

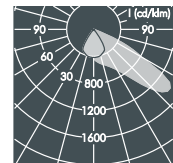
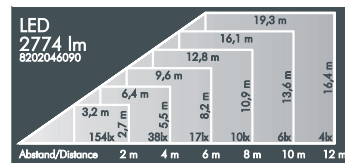

Part number	Colour	Weight	Light source	Luminous flux	Main beam angle γ
8 202 045 099	black	2.8 kg	1 x LED module 27 W	2913 lm	53°
8 202 065 099	white		neutral white (4000 K)		
8 202 055 099	silver grey				

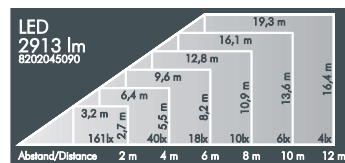

Part number	Description
... 1..	Dimmable luminaire (DALI)

LED

Luminaires available in 2700 K and other colour temperatures upon request



Monoflood 2 with mounting bracket lens optics

With 5 x high performance LEDs,
integral temperature monitoring device,
CRI: > 80, Colour tolerance: max. 2 SDCM
Service life: L90/B10 > 50 000 h
protection class I, IP65 , IK08
windage area AW 0.024 m²
corrosion-resistant die cast aluminium housing AISi12,
polyester powder coated,
precise PMMA optics,
all exterior steel parts are stainless steel,
tempered safety glass, silicon gasket,
closure with 4 stainless steel screws,
mounting bracket: 2 drilled holes Ø 7 mm,
spacing 30 - 40 mm, 1 centre hole Ø 17 mm,
tilt range 180°, M16 cable gland,
integral driver (AC/DC)

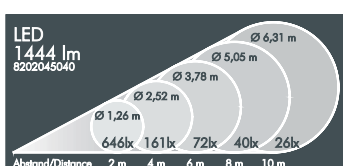
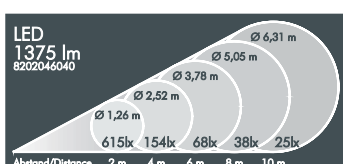
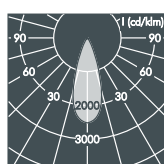
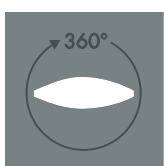
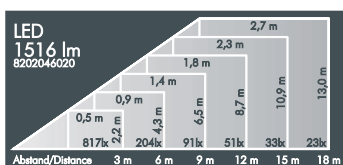
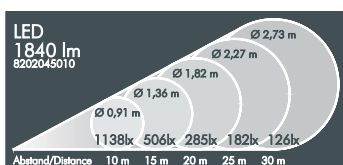
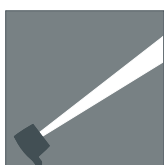
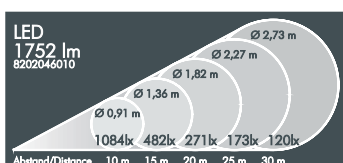
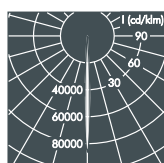
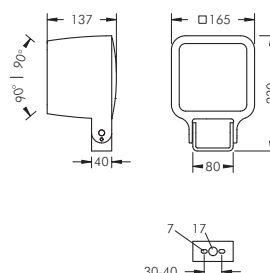

Monoflood 2, narrow beam

Part number	Colour	Weight	Light source	Luminous flux	Beam angle γ (FWHM)
8 202 046 019	black	3.0 kg	5 x LED 5.6 W (28 W)	1752 lm	5°
8 202 066 019	white		warm white (3000 K)		
8 202 056 019	silver grey				

Part number	Colour	Weight	Light source	Luminous flux	Beam angle γ (FWHM)
8 202 045 019	black	3.0 kg	5 x LED 5.6 W (28 W)	1840 lm	5°
8 202 065 019	white		neutral white (4000 K)		
8 202 055 019	silver grey				

Monoflood 2, linear beam spread, vertical

Part number	Colour	Weight	Light source	Luminous flux	Beam angle γ (FWHM)
8 202 046 029	black	3.0 kg	5 x LED 5.6 W (28 W)	1516 lm	C 0 - 180 40°
8 202 066 029	white		warm white (3000 K)		C 90 - 270 9°
8 202 056 029	silver grey				

... 3. Luminaire with linear beam spread, horizontal

Monoflood 2, linear beam spread, rotatable

Part number	Colour	Description	Luminous flux	Beam angle γ (FWHM)
8 202 046 079	black	Luminaire with external ribbed glass spreader lens, continuously adjustable through 360° from outside the luminaire	1364 lm	C 0 - 180
8 202 066 079	white			7°
8 202 056 079	silver grey			29°
Weight 3.2 kg				

Monoflood 2, medium wide beam

Part number	Colour	Weight	Light source	Luminous flux	Beam angle γ (FWHM)
8 202 046 049	black	3.0 kg	5 x LED 5.6 W (28 W)	1375 lm	35°
8 202 066 049	white		warm white (3000 K)		
8 202 056 049	silver grey				

Part number	Colour	Weight	Light source	Luminous flux	Beam angle γ (FWHM)
8 202 045 049	black	3.0 kg	5 x LED 5.6 W (28 W)	1444 lm	35°
8 202 065 049	white		neutral white (4000 K)		
8 202 055 049	silver grey				

Part number	Description
... 5 ...	Luminaire with neutral white colour temperature (4000 K)
... 1 ...	Dimmable luminaire (DALI)

LED

Luminaires available in 2700 K and other colour temperatures upon request



Monoflood 3 with mounting bracket reflector optic

With a high performance LED module (Zhaga), integral temperature monitoring device, CRI: > 85, Colour tolerance: max. 2 SDCM
Service life: L90/B10 > 50 000 h
protection class I, IP65 , IK08
windage area AW 0.032 m²
corrosion-resistant die cast aluminium housing AlSi12, polyester powder coated,
highly efficient aluminium reflector,
all exterior steel parts are stainless steel,
tempered safety glass, silicon gasket,
closure with 4 stainless steel screws,
mounting bracket: 2 drilled holes Ø 7 mm,
spacing 30 - 40 mm, 1 centre hole Ø 17 mm,
tilt range 180°, M20 cable gland,
integral driver (AC/DC)

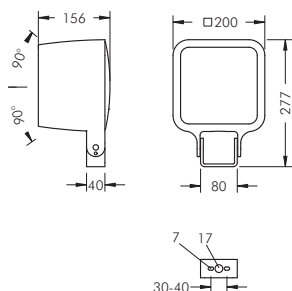

Monoflood 3, axially symmetrical wide beam

Part number	Colour	Weight	Light source	Luminous flux	Beam angle γ (FWHM)	
8 203 046 059	black	4.2 kg	1 x LED module 52 W warm white (3000 K)	5252 lm	C 0 – 180	C 90 – 270
8 203 066 059	white				63°	67°
8 203 056 059	silver grey					

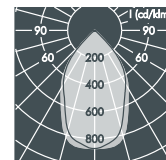
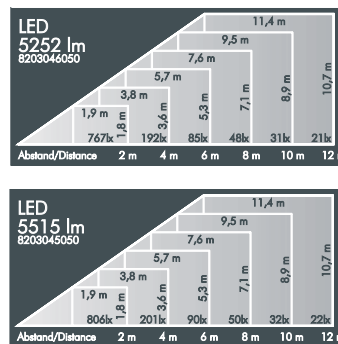

Part number	Colour	Weight	Light source	Luminous flux	Beam angle γ (FWHM)	
8 203 045 059	black	4.2 kg	1 x LED module 52 W neutral white (4000 K)	5515 lm	C 0 – 180	C 90 – 270
8 203 065 059	white				63°	67°
8 203 055 059	silver grey					

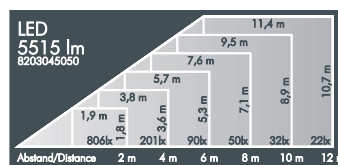

Monoflood 3, axially symmetrical narrow beam

Part number	Colour	Weight	Light source	Luminous flux	Beam angle γ (FWHM)	
8 203 046 069	black	4.2 kg	1 x LED module 52 W warm white (3000 K)	5092 lm	C 0 – 180	C 90 – 270
8 203 066 069	white				45°	69°
8 203 056 069	silver grey					

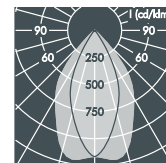
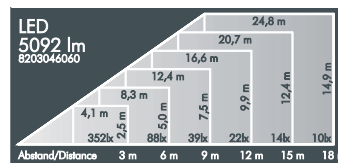

Part number	Colour	Weight	Light source	Luminous flux	Beam angle γ (FWHM)	
8 203 045 069	black	4.2 kg	1 x LED module 52 W neutral white (4000 K)	5347 lm	C 0 – 180	C 90 – 270
8 203 065 069	white				45°	69°
8 203 055 069	silver grey					

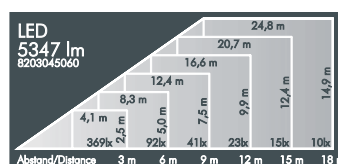

Monoflood 3, asymmetrical beam

Part number	Colour	Weight	Light source	Luminous flux	Main beam angle γ
8 203 046 099	black	4.2 kg	1 x LED module 52 W warm white (3000 K)	4792 lm	56°
8 203 066 099	white				
8 203 056 099	silver grey				

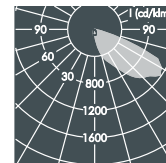
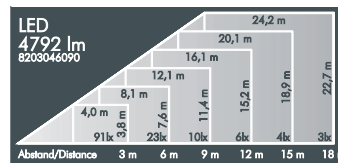

Part number	Colour	Weight	Light source	Luminous flux	Main beam angle γ
8 203 045 099	black	4.2 kg	1 x LED module 52 W neutral white (4000 K)	5035 lm	56°
8 203 065 099	white				
8 203 055 099	silver grey				

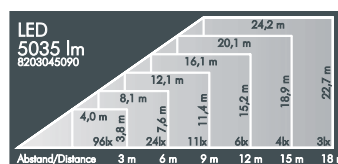

Part number	Description
... 1..	Dimmable luminaire (DALI)

LED

Luminaires available in 2700 K and other colour temperatures upon request



Monoflood 3 with mounting bracket lens optics

With 9 x high performance LEDs,
integral temperature monitoring device,
CRI: > 80, Colour tolerance: max. 2 SDCM
Service life: L90/B10 > 50 000 h
protection class I, IP65 \triangle \triangle , IK08
windage area AW 0.032 m²
corrosion-resistant die cast aluminium housing AISi12,
polyester powder coated,
precise PMMA optics,
all exterior steel parts are stainless steel,
tempered safety glass, silicon gasket,
closure with 4 stainless steel screws,
mounting bracket: 2 drilled holes \varnothing 7 mm,
spacing 30 - 40 mm, 1 centre hole \varnothing 17 mm,
tilt range 180°, M20 cable gland,
integral driver (AC/DC) or
integral RGBW driver (DMX - RDM)

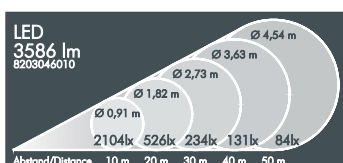
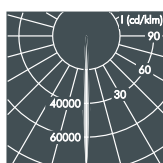
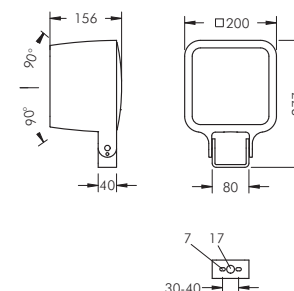

Monoflood 3, narrow beam

Part number	Colour	Weight	Light source	Luminous flux	Beam angle γ (FWHM)
8 203 046 019	black	4.5 kg	9 x LED 6 W	3586 lm	5°
8 203 066 019	white		(54 W)		
8 203 056 019	silver grey		warm white (3000 K)		

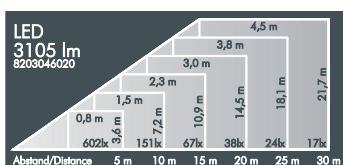

Monoflood 3, linear beam spread, vertical

Part number	Colour	Weight	Light source	Luminous flux	Beam angle γ (FWHM)
8 203 046 029	black	4.5 kg	9 x LED 6 W	3105 lm	C 0 - 180
8 203 066 029	white		(54 W)		C 90 - 270
8 203 056 029	silver grey		warm white (3000 K)		40°

... .3. Luminaire with linear beam spread, horizontal

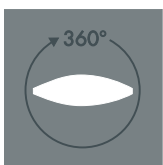

Monoflood 3, linear beam spread, rotatable

Part number	Colour	Description	Luminous flux	Beam angle γ (FWHM)
8 203 046 079	black	Luminaire with external	2795 lm	C 0 - 180
8 203 066 079	white	ribbed glass spreader lens,		C 90 - 270
8 203 056 079	silver grey	continuously adjustable through 360° from outside the luminaire		7°
		Weight 4.7 kg		29°

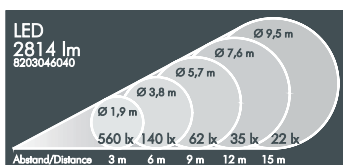
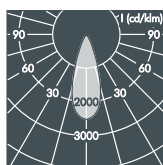

Monoflood 3, medium wide beam

Part number	Colour	Weight	Light source	Luminous flux	Beam angle γ (FWHM)
8 203 046 049	black	4.5 kg	9 x LED 6 W	2814 lm	35°
8 203 066 049	white		(54 W)		
8 203 056 049	silver grey		warm white (3000 K)		

Part number Description

... .5 ... **Luminaire with neutral white colour temperature (4000 K)**

... .1 ... **Dimmable luminaire (DALI)**

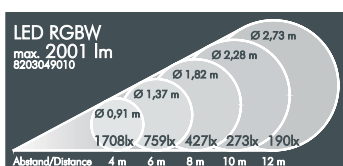
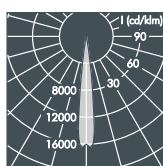

Monoflood 3 RGBW, narrow beam

Part number	Colour	Weight	Light source	Luminous flux	Beam angle γ (FWHM)
8 203 049 019	black	4.6 kg	9 x LED module RGBW	max.	13°
8 203 069 019	white		W = 3000 K	2001 lm	
8 203 059 019	silver grey		(max. 52 W)		

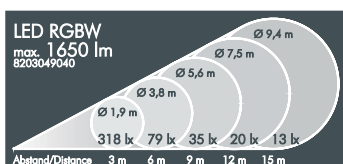
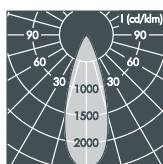

Monoflood 3 RGBW, medium wide beam

Part number	Colour	Weight	Light source	Luminous flux	Beam angle γ (FWHM)
8 203 049 049	black	4.6 kg	9 x LED module RGBW	max.	35°
8 203 069 049	white		W = 3000 K	1650 lm	
8 203 059 049	silver grey		(max. 52 W)		

LED

Luminaires available in 2700 K and other colour temperatures upon request



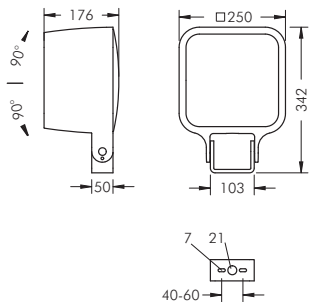

Monoflood 4 with mounting bracket reflector optic

With a high performance LED module (Zhaga), integral temperature monitoring device, CRI: > 85, Colour tolerance: max. 2 SDCM Service life: L90/B10 > 50 000 h protection class I, IP65 \triangle \triangle \triangle , IK08 windage area AW 0.046 m² corrosion-resistant die cast aluminium housing AlSi12, polyester powder coated, highly efficient aluminium reflector, all exterior steel parts are stainless steel, tempered safety glass, silicon gasket, closure with 4 stainless steel screws, mounting bracket: 2 drilled holes \varnothing 7 mm, spacing 40 - 60 mm, 1 centre hole \varnothing 21 mm, tilt range 180°, M20 cable gland, integral driver (AC/DC)

Monoflood 4, axially symmetrical wide beam

Part number	Colour	Weight	Light source	Luminous flux	Beam angle γ (FWHM)	
8 204 046 059	black	6.2 kg	4 x LED module 25.5 W	12131 lm	C 0 - 180	C 90 - 270
8 204 066 059	white		(102 W)		65°	66°
8 204 056 059	silver grey		warm white (3000 K)			

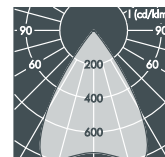
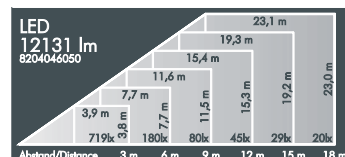

Part number	Colour	Weight	Light source	Luminous flux	Beam angle γ (FWHM)	
8 204 045 059	black	6.2 kg	4 x LED module 25.5 W	12738 lm	C 0 - 180	C 90 - 270
8 204 065 059	white		(102 W)		65°	66°
8 204 055 059	silver grey		neutral white (4000 K)			

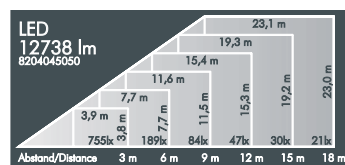

Monoflood 4, axially symmetrical narrow beam

Part number	Colour	Weight	Light source	Luminous flux	Beam angle γ (FWHM)	
8 204 046 069	black	6.2 kg	4 x LED module 25.5 W	10952 lm	C 0 - 180	C 90 - 270
8 204 066 069	white		(102 W)		43°	62°
8 204 056 069	silver grey		warm white (3000 K)			

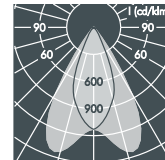
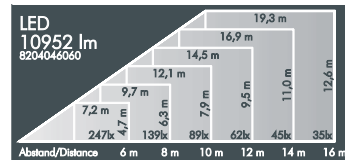

Part number	Colour	Weight	Light source	Luminous flux	Beam angle γ (FWHM)	
8 204 045 069	black	6.2 kg	4 x LED module 25.5 W	11501 lm	C 0 - 180	C 90 - 270
8 204 065 069	white		(102 W)		43°	62°
8 204 055 069	silver grey		neutral white (4000 K)			

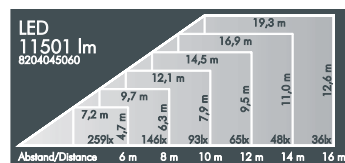

Monoflood 4, asymmetrical beam

Part number	Colour	Weight	Light source	Luminous flux	Main beam angle γ
8 204 046 099	black	6.2 kg	2 x LED module 52 W	9215 lm	65°
8 204 066 099	white		(104 W)		
8 204 056 099	silver grey		warm white (3000 K)		

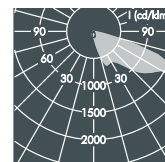
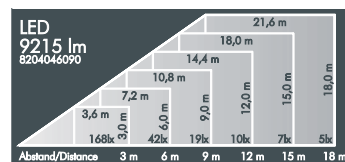

Part number	Colour	Weight	Light source	Luminous flux	Main beam angle γ
8 204 045 099	black	6.2 kg	2 x LED module 52 W	9675 lm	65°
8 204 065 099	white		(104 W)		
8 204 055 099	silver grey		neutral white (4000 K)		

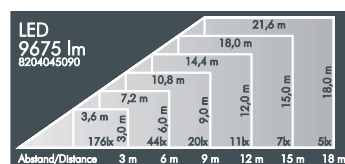

Part number	Description
... 1..	Dimmable luminaire (DALI)

LED

Luminaires available in 2700 K and other colour temperatures upon request



Monoflood 4 with mounting bracket lens optics

With 13 x high performance LEDs,
integral temperature monitoring device,
CRI: > 80, Colour tolerance: max. 3 SDCM
Service life: L90/B10 > 50 000 h
protection class I, IP65 , IK08
windage area AW 0.046 m²
corrosion-resistant die cast aluminium housing AISi12,
polyester powder coated,
precise PMMA optics,
all exterior steel parts are stainless steel,
tempered safety glass, silicon gasket,
closure with 4 stainless steel screws,
mounting bracket: 2 drilled holes Ø 7 mm,
spacing 40 - 60 mm, 1 centre hole Ø 21 mm,
tilt range 180°, M20 cable gland,
integral driver (AC/DC) or
integral RGBW driver (DMX - RDM)

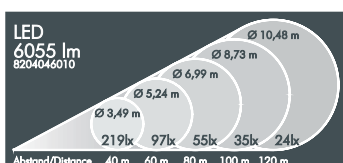
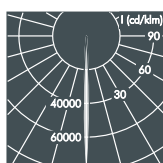
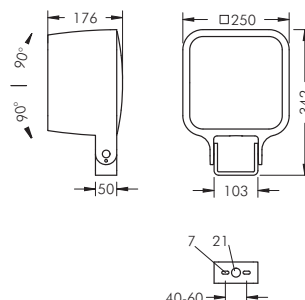

Monoflood 4, narrow beam

Part number	Colour	Weight	Light source	Luminous flux	Beam angle γ (FWHM)
8 204 046 019	black	6.6 kg	13 x LED 7.5 W	6055 lm	5°
8 204 066 019	white		(98 W)		
8 204 056 019	silver grey		warm white (3000 K)		

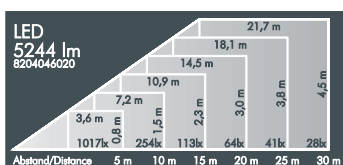

Monoflood 4, linear beam spread, vertical

Part number	Colour	Weight	Light source	Luminous flux	Beam angle γ (FWHM)
8 204 046 029	black	6.6 kg	13 x LED 7.5 W	5244 lm	C 0 - 180
8 204 066 029	white		(98 W)		40°
8 204 056 029	silver grey		warm white (3000 K)		9°

... .3. Luminaire with linear beam spread, horizontal

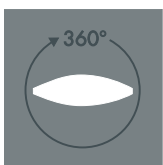

Monoflood 4, linear beam spread, rotatable

Part number	Colour	Description	Luminous flux	Beam angle γ (FWHM)
8 204 046 079	black	Luminaire with external	4720 lm	C 0 - 180
8 204 066 079	white	ribbed glass spreader lens,		7°
8 204 056 079	silver grey	continuously adjustable through 360°		29°
Weight 7.2 kg				

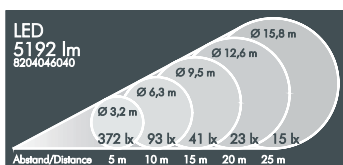
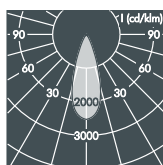

Monoflood 4, medium wide beam

Part number	Colour	Weight	Light source	Luminous flux	Beam angle γ (FWHM)
8 204 046 049	black	6.6 kg	13 x LED 7.5 W	5192 lm	35°
8 204 066 049	white		(98 W)		
8 204 056 049	silver grey		warm white (3000 K)		

Part number	Description
... .5 ...	Luminaire with neutral white colour temperature (4000 K)
... .1 ...	Dimmable luminaire (DALI)

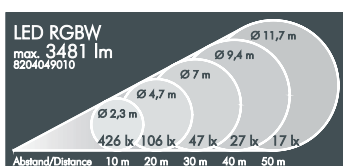
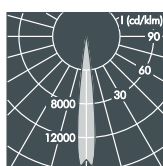

Monoflood 4 RGBW, narrow beam

Part number	Colour	Weight	Light source	Luminous flux	Beam angle γ (FWHM)
8 204 049 019	black	6.9 kg	13 x LED module RGBW	max.	13°
8 204 069 019	white		W = 3000 K	3481 lm	
8 204 059 019	silver grey		(max. 105 W)		

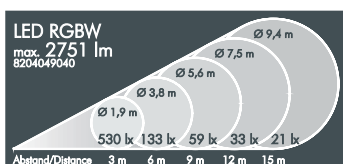
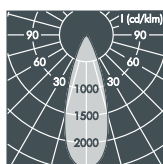

Monoflood 4 RGBW, medium wide beam

Part number	Colour	Weight	Light source	Luminous flux	Beam angle γ (FWHM)
8 204 049 049	black	6.9 kg	13 x LED module RGBW	max.	35°
8 204 069 049	white		W = 3000 K	2751 lm	
8 204 059 049	silver grey		(max. 105 W)		

LED

Luminaires available in 2700 K and other colour temperatures upon request



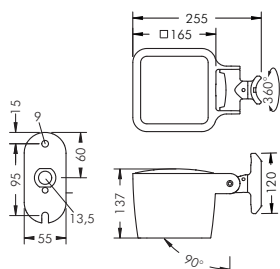

Monoflood 2 pole luminaire reflector optic

With a high performance LED module (Zhaga), integral temperature monitoring device, CRI: > 85, Colour tolerance: max. 2 SDCM Service life: L90/B10 > 50 000 h protection class I, IP65 , IK08 windage area AW 0.026 m² corrosion-resistant die cast aluminium housing AlSi12, polyester powder coated, highly efficient aluminium reflector or lens made of optical silicon (Street Optic), all exterior steel parts are stainless steel, tempered safety glass, silicon gasket, closure with 4 stainless steel screws, for installation on poles Ø 60 - 100 mm, tiltable base made of powder coated aluminium, 2 drilled holes Ø 9 mm, spacing 95 mm, 1 drilled hole Ø 13.5 mm, tilt range 90° swivel range 360°, M16 cable gland, integral driver (AC/DC)

Monoflood 2 pole luminaire, axially symmetrical wide beam

Part number	Colour	Weight	Light source	Luminous flux	Beam angle γ (FWHM)	
8 202 246 059	black	3.0 kg	1 x LED module 27 W	3009 lm	C 0 – 180	C 90 – 270
8 202 266 059	white		warm white (3000 K)		88°	89°
8 202 256 059	silver grey					

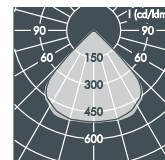
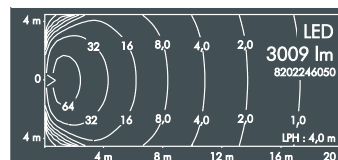

Part number	Colour	Weight	Light source	Luminous flux	Beam angle γ (FWHM)	
8 202 245 059	black	3.0 kg	1 x LED module 27 W	3159 lm	C 0 – 180	C 90 – 270
8 202 265 059	white		neutral white (4000 K)		88°	89°
8 202 255 059	silver grey					

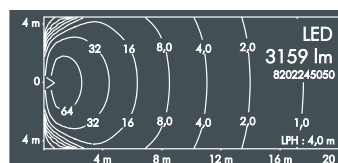

Monoflood 2 pole luminaire, axially symmetrical narrow beam

Part number	Colour	Weight	Light source	Luminous flux	Beam angle γ (FWHM)	
8 202 246 069	black	3.0 kg	1 x LED module 27 W	2884 lm	C 0 – 180	C 90 – 270
8 202 266 069	white		warm white (3000 K)		55°	86°
8 202 256 069	silver grey					

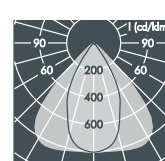
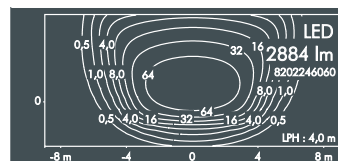

Part number	Colour	Weight	Light source	Luminous flux	Beam angle γ (FWHM)	
8 202 245 069	black	3.0 kg	1 x LED module 27 W	3028 lm	C 0 – 180	C 90 – 270
8 202 265 069	white		neutral white (4000 K)		55°	86°
8 202 255 069	silver grey					

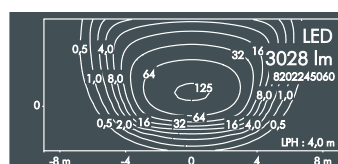

Monoflood 2 pole luminaire, asymmetrical beam

Part number	Colour	Weight	Light source	Luminous flux	Main beam angle γ
8 202 246 099	black	3.0 kg	1 x LED module 27 W	2774 lm	53°
8 202 266 099	white		warm white (3000 K)		
8 202 256 099	silver grey				

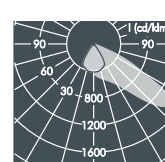
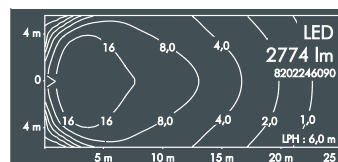

Part number	Colour	Weight	Light source	Luminous flux	Main beam angle γ
8 202 245 099	black	3.0 kg	1 x LED module 27 W	2913 lm	53°
8 202 265 099	white		neutral white (4000 K)		
8 202 255 099	silver grey				

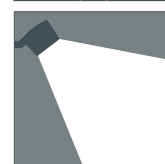
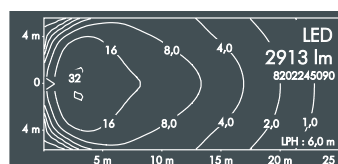

Monoflood 2 pole luminaire, Street Optic

Part number	Colour	Weight	Light source	Luminous flux	Beam angle γ (FWHM)	
8 202 246 089	black	3.3 kg	1 x LED module 27 W	2890 lm	C 0 – 180	C 90 – 270
8 202 266 089	white		warm white (3000 K)		51°	121°
8 202 256 089	silver grey					

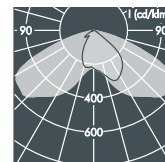
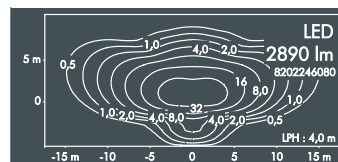

Part number	Description
... .. 5 ...	Luminaire with neutral white colour temperature (4000 K)
... .. 1 ..	Dimmable luminaire (DALI)

LED

Luminaires available in 2700 K and other colour temperatures upon request



Monoflood 2 pole luminaire lens optics

With 5 x high performance LEDs,
 integral temperature monitoring device,
 CRI: > 80, Colour tolerance: max. 2 SDCM
 Service life: L90/B10 > 50 000 h
 protection class I, IP65 , IK08
 windage area AW 0.026 m²
 corrosion-resistant die cast aluminium housing AISi12,
 polyester powder coated,
 precise PMMA optics,
 all exterior steel parts are stainless steel,
 tempered safety glass, silicon gasket,
 closure with 4 stainless steel screws,
 for installation on poles Ø 60 - 100 mm,
 tiltable base made of powder coated aluminium,
 2 drilled holes Ø 9 mm, spacing 95 mm,
 1 drilled hole Ø 13.5 mm, tilt range 90°
 swivel range 360°, M16 cable gland,
 integral driver (AC/DC)

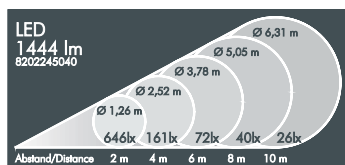
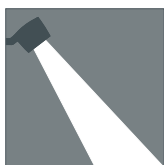
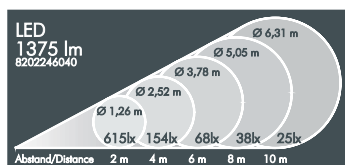
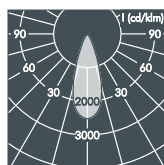
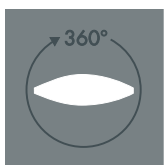
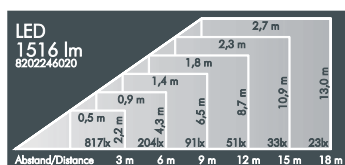
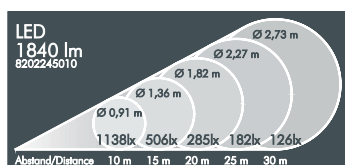
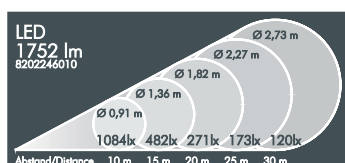
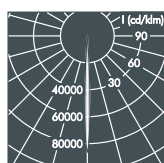
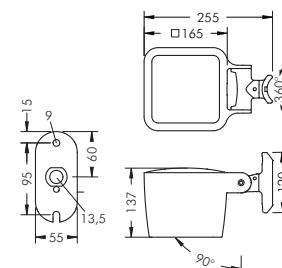

Monoflood 2 pole luminaire, narrow beam

Part number	Colour	Weight	Light source	Luminous flux	Beam angle γ (FWHM)
8 202 246 019	black	3.2 kg	5 x LED 5.6 W (28 W)	1752 lm	5°
8 202 266 019	white		warm white (3000 K)		
8 202 256 019	silver grey				

Part number	Colour	Weight	Light source	Luminous flux	Beam angle γ (FWHM)
8 202 245 019	black	3.2 kg	5 x LED 5.6 W (28 W)	1840 lm	5°
8 202 265 019	white		neutral white (4000 K)		
8 202 255 019	silver grey				

Monoflood 2 pole luminaire, linear beam spread, vertical

Part number	Colour	Weight	Light source	Luminous flux	Beam angle γ (FWHM)
8 202 246 029	black	3.2 kg	5 x LED 5.6 W (28 W)	1516 lm	C 0 - 180
8 202 266 029	white		warm white (3000 K)		C 90 - 270
8 202 256 029	silver grey				40°

... .3. Luminaire with linear beam spread, horizontal

Monoflood 2 pole luminaire, linear beam spread, rotatable

Part number	Colour	Description	Luminous flux	Beam angle γ (FWHM)
8 202 246 079	black	Luminaire with external ribbed glass spreader lens, continuously adjustable through 360° from outside the luminaire	1364 lm	C 0 - 180
8 202 266 079	white			
8 202 256 079	silver grey			
Weight 3.4 kg				29°

Monoflood 2 pole luminaire, medium wide beam

Part number	Colour	Weight	Light source	Luminous flux	Beam angle γ (FWHM)
8 202 246 049	black	3.2 kg	5 x LED 5.6 W (28 W)	1375 lm	35°
8 202 266 049	white		warm white (3000 K)		
8 202 256 049	silver grey				

Part number	Colour	Weight	Light source	Luminous flux	Beam angle γ (FWHM)
8 202 245 049	black	3.2 kg	5 x LED 5.6 W (28 W)	1444 lm	35°
8 202 265 049	white		neutral white (4000 K)		
8 202 255 049	silver grey				

Part number	Description
... .5 ...	Luminaire with neutral white colour temperature (4000 K)
... .1 ...	Dimmable luminaire (DALI)

LED

Luminaires available in 2700 K and other colour temperatures upon request



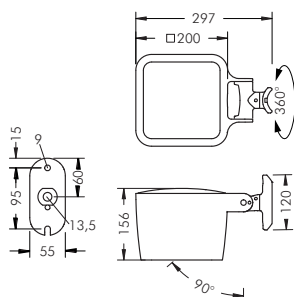

Monoflood 3 pole luminaire reflector optic

With a high performance LED module (Zhaga), integral temperature monitoring device, CRI: > 85, Colour tolerance: max. 2 SDCM Service life: L90/B10 > 50 000 h protection class I, IP65 , IK08 windage area AW 0.034 m² corrosion-resistant die cast aluminium housing AlSi12, polyester powder coated, highly efficient aluminium reflector or lens made of optical silicon (Street Optic), all exterior steel parts are stainless steel, tempered safety glass, silicon gasket, closure with 4 stainless steel screws, for installation on poles Ø 60 - 100 mm, tiltable base made of powder coated aluminium, 2 drilled holes Ø 9 mm, spacing 95 mm, 1 drilled hole Ø 13.5 mm, tilt range 90° swivel range 360°, M20 cable gland, integral driver (AC/DC)

Monoflood 3 pole luminaire, axially symmetrical wide beam

Part number	Colour	Weight	Light source	Luminous flux	Beam angle γ (FWHM)	
8 203 246 059	black	4.4 kg	1 x LED module 52 W warm white (3000 K)	5252 lm	C 0 – 180	C 90 – 270
8 203 266 059	white				63°	67°
8 203 256 059	silver grey					

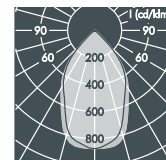
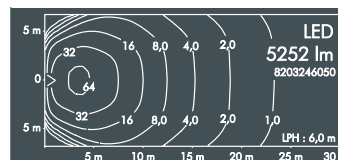

Part number	Colour	Weight	Light source	Luminous flux	Beam angle γ (FWHM)	
8 203 245 059	black	4.4 kg	1 x LED module 52 W neutral white (4000 K)	5515 lm	C 0 – 180	C 90 – 270
8 203 265 059	white				63°	67°
8 203 255 059	silver grey					

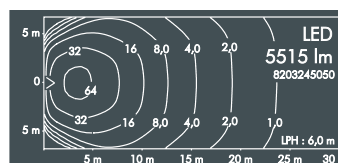

Monoflood 3 pole luminaire, axially symmetrical narrow beam

Part number	Colour	Weight	Light source	Luminous flux	Beam angle γ (FWHM)	
8 203 246 069	black	4.4 kg	1 x LED module 52 W warm white (3000 K)	5092 lm	C 0 – 180	C 90 – 270
8 203 266 069	white				45°	69°
8 203 256 069	silver grey					

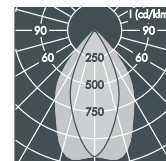
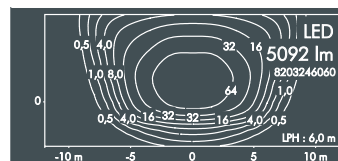

Part number	Colour	Weight	Light source	Luminous flux	Beam angle γ (FWHM)	
8 203 245 069	black	4.4 kg	1 x LED module 52 W neutral white (4000 K)	5347 lm	C 0 – 180	C 90 – 270
8 203 265 069	white				45°	69°
8 203 255 069	silver grey					

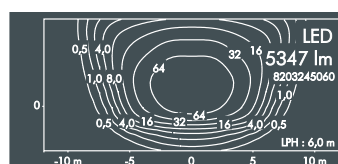

Monoflood 3 pole luminaire, asymmetrical beam

Part number	Colour	Weight	Light source	Luminous flux	Main beam angle γ
8 203 246 099	black	4.4 kg	1 x LED module 52 W warm white (3000 K)	4792 lm	56°
8 203 266 099	white				
8 203 256 099	silver grey				

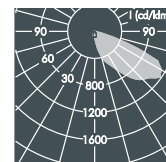
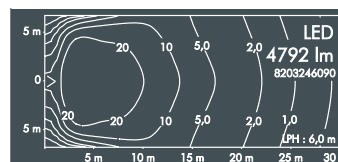

Part number	Colour	Weight	Light source	Luminous flux	Main beam angle γ
8 203 245 099	black	4.4 kg	1 x LED module 52 W neutral white (4000 K)	5035 lm	56°
8 203 265 099	white				
8 203 255 099	silver grey				

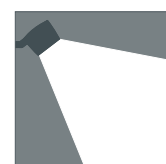
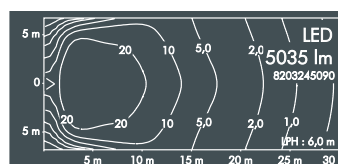

Monoflood 3 pole luminaire, Street Optic

Part number	Colour	Weight	Light source	Luminous flux	Beam angle γ (FWHM)	
8 203 246 089	black	4.7 kg	1 x LED module 52 W warm white (3000 K)	5088 lm	C 0 – 180	C 90 – 270
8 203 266 089	white				51°	121°
8 203 256 089	silver grey					

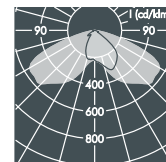
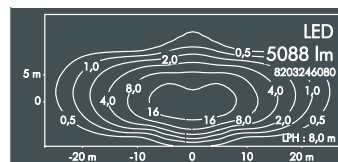

Part number	Description
... . 5 ...	Luminaire with neutral white colour temperature (4000 K)
... . 1 ..	Dimmable luminaire (DALI)

LED

Luminaires available in 2700 K and other colour temperatures upon request



Monoflood 3 pole luminaire lens optics

With 9 x high performance LEDs,
 integral temperature monitoring device,
 CRI: > 80, Colour tolerance: max. 3 SDCM
 Service life: L90/B10 > 50 000 h
 protection class I, IP65 \triangle \triangle , IK08
 windage area AW 0.034 m²
 corrosion-resistant die cast aluminium housing AISI12,
 polyester powder coated,
 precise PMMA optics,
 all exterior steel parts are stainless steel,
 tempered safety glass, silicon gasket,
 closure with 4 stainless steel screws,
 for installation on poles \varnothing 60 - 100 mm,
 tiltable base made of powder coated aluminium,
 2 drilled holes \varnothing 9 mm, spacing 95 mm,
 1 drilled hole \varnothing 13.5 mm, tilt range 90°
 swivel range 360°, M20 cable gland,
 integral driver (AC/DC) or
 integral RGBW driver (DMX - RDM)

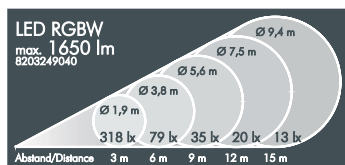
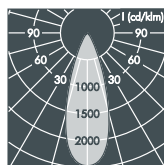
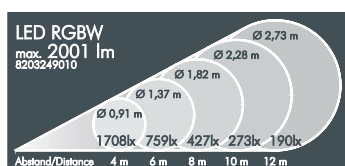
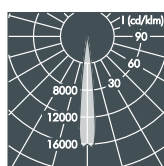
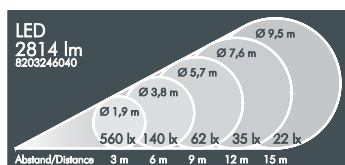
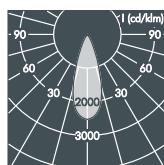
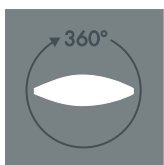
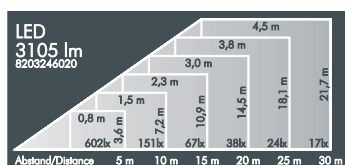
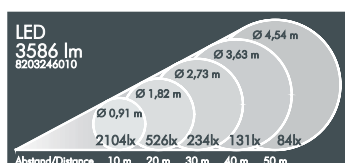
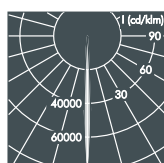
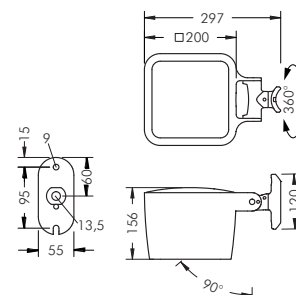

LED

Luminaires available in 2700 K and other colour temperatures upon request



Monoflood 3 pole luminaire, narrow beam

Part number	Colour	Weight	Light source	Luminous flux	Beam angle γ (FWHM)
8 203 246 019	black	4.7 kg	9 x LED 6 W (54 W) warm white (3000 K)	3586 lm	5°
8 203 266 019	white				
8 203 256 019	silver grey				

Monoflood 3 pole luminaire, linear beam spread, vertical

Part number	Colour	Weight	Light source	Luminous flux	Beam angle γ (FWHM)
8 203 246 029	black	4.7 kg	9 x LED 6 W (54 W) warm white (3000 K)	3105 lm	C 0 - 180
8 203 266 029	white	C 90 - 270			
8 203 256 029	silver grey	40°			9°

... .3. Luminaire with linear beam spread, horizontal

Monoflood 3 pole luminaire, linear beam spread, rotatable

Part number	Colour	Description	Luminous flux	Beam angle γ (FWHM)
8 203 246 079	black	Luminaire with external ribbed glass spreader lens, continuously adjustable through 360° from outside the luminaire	2795 lm	C 0 - 180
8 203 266 079	white			C 90 - 270
8 203 256 079	silver grey			7°

Weight 4.9 kg

Monoflood 3 pole luminaire, medium wide beam

Part number	Colour	Weight	Light source	Luminous flux	Beam angle γ (FWHM)
8 203 246 049	black	4.7 kg	9 x LED 6 W (54 W) warm white (3000 K)	2814 lm	35°
8 203 266 049	white				
8 203 256 049	silver grey				

Part number	Description
... .5 ...	Luminaire with neutral white colour temperature (4000 K)
... .1 ...	Dimmable luminaire (DALI)

Monoflood 3 RGBW pole luminaire, narrow beam

Part number	Colour	Weight	Light source	Luminous flux	Beam angle γ (FWHM)
8 203 249 019	black	4.8 kg	9 x LED module RGBW W = 3000 K (max. 52 W)	max. 2001 lm	13°
8 203 269 019	white				
8 203 259 019	silver grey				

Monoflood 3 RGBW pole luminaire, medium wide beam

Part number	Colour	Weight	Light source	Luminous flux	Beam angle γ (FWHM)
8 203 249 049	black	4.8 kg	9 x LED module RGBW W = 3000 K (max. 52 W)	max. 1650 lm	35°
8 203 269 049	white				
8 203 259 049	silver grey				

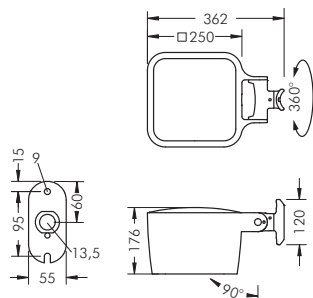

Monoflood 4 pole luminaire reflector optic

With a high performance LED module (Zhaga), integral temperature monitoring device, CRI: > 85, Colour tolerance: max. 2 SDCM Service life: L90/B10 > 50 000 h protection class I, IP65 , IK08 windage area AW 0.048 m² corrosion-resistant die cast aluminium housing AlSi12, polyester powder coated, highly efficient aluminium reflector, all exterior steel parts are stainless steel, tempered safety glass, silicon gasket, closure with 4 stainless steel screws, for installation on poles Ø 60 - 100 mm, tiltable base made of powder coated aluminium, 2 drilled holes Ø 9 mm, spacing 95 mm, 1 drilled hole Ø 13.5 mm, tilt range 90° swivel range 360°, M20 cable gland, integral driver (AC/DC)

Monoflood 4 pole luminaire, axially symmetrical wide beam

Part number	Colour	Weight	Light source	Luminous flux	Beam angle γ (FWHM)	
8 204 246 059	black	6.5 kg	4 x LED module 25.5 W	12131 lm	C 0 – 180	C 90 – 270
8 204 266 059	white		(102 W)		65°	66°
8 204 256 059	silver grey		warm white (3000 K)			

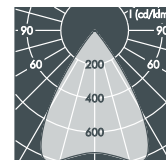
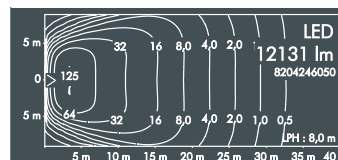

Part number	Colour	Weight	Light source	Luminous flux	Beam angle γ (FWHM)	
8 204 245 059	black	6.5 kg	4 x LED module 25.5 W	12738 lm	C 0 – 180	C 90 – 270
8 204 265 059	white		(102 W)		65°	66°
8 204 255 059	silver grey		neutral white (4000 K)			

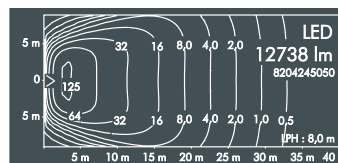

Monoflood 4 pole luminaire, axially symmetrical narrow beam

Part number	Colour	Weight	Light source	Luminous flux	Beam angle γ (FWHM)	
8 204 246 069	black	6.5 kg	4 x LED module 25.5 W	10952 lm	C 0 – 180	C 90 – 270
8 204 266 069	white		(102 W)		43°	62°
8 204 256 069	silver grey		warm white (3000 K)			

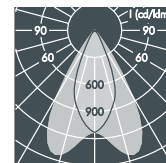
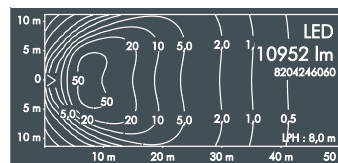

Part number	Colour	Weight	Light source	Luminous flux	Beam angle γ (FWHM)	
8 204 245 069	black	6.5 kg	4 x LED module 25.5 W	11501 lm	C 0 – 180	C 90 – 270
8 204 265 069	white		(102 W)		43°	62°
8 204 255 069	silver grey		neutral white (4000 K)			

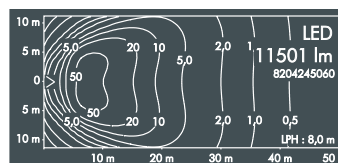

Monoflood 4 pole luminaire, asymmetrical beam

Part number	Colour	Weight	Light source	Luminous flux	Main beam angle γ
8 204 246 099	black	6.5 kg	2 x LED module 52 W	9215 lm	65°
8 204 266 099	white		(104 W)		
8 204 256 099	silver grey		warm white (3000 K)		

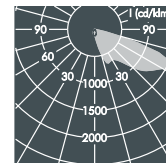
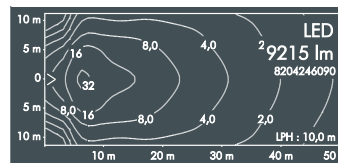

Part number	Colour	Weight	Light source	Luminous flux	Main beam angle γ
8 204 245 099	black	6.5 kg	2 x LED module 52 W	9675 lm	65°
8 204 265 099	white		(104 W)		
8 204 255 099	silver grey		neutral white (4000 K)		

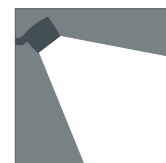
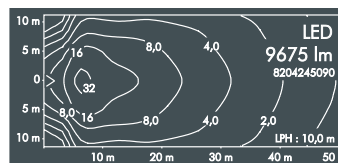

Part number	Description
. 1..	Dimmable luminaire (DALI)

LED

Luminaires available in 2700 K and other colour temperatures upon request



Monoflood 4 pole luminaire lens optics

With 13 x high performance LEDs, integral temperature monitoring device, CRI: > 80, Colour tolerance: max. 3 SDCM Service life: L90/B10 > 50 000 h protection class I, IP65 \triangle \triangle , IK08 windage area AW 0.048 m² corrosion-resistant die cast aluminium housing AISi12, polyester powder coated, precise PMMA optics, all exterior steel parts are stainless steel, tempered safety glass, silicon gasket, closure with 4 stainless steel screws, for installation on poles \varnothing 60 - 100 mm, tiltable base made of powder coated aluminium, 2 drilled holes \varnothing 9 mm, spacing 95 mm, 1 drilled hole \varnothing 13.5 mm, tilt range 90°, swivel range 360°, M20 cable gland, integral driver (AC/DC) or integral RGBW driver (DMX - RDM)

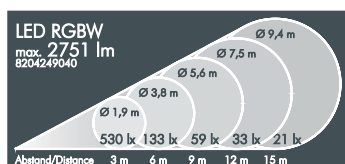
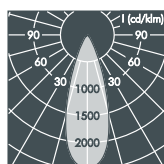
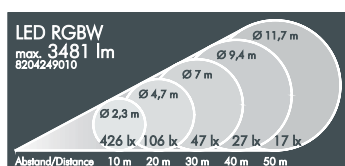
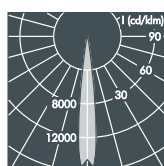
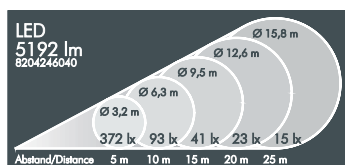
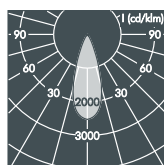
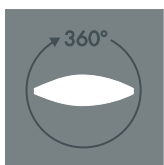
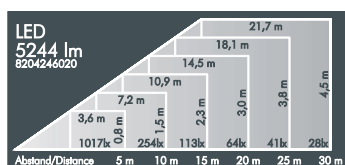
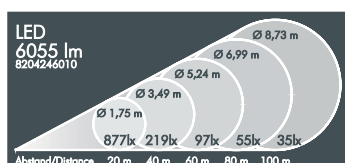
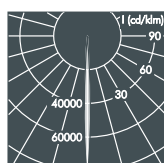
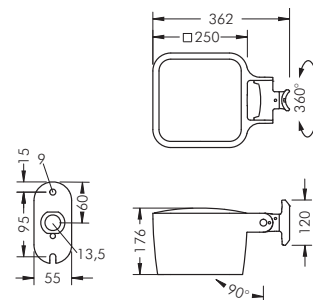

LED

Luminaires available in 2700 K and other colour temperatures upon request



Monoflood 4 pole luminaire, narrow beam

Part number	Colour	Weight	Light source	Luminous flux	Beam angle γ (FWHM)
8 204 246 019	black	6.9 kg	13 x LED 7.5 W	6055 lm	5°
8 204 266 019	white		(98 W)		
8 204 256 019	silver grey		warm white (3000 K)		

Monoflood 4 pole luminaire, linear beam spread, vertical

Part number	Colour	Weight	Light source	Luminous flux	Beam angle γ (FWHM)
8 204 246 029	black	6.9 kg	13 x LED 7.5 W	5244 lm	C 0 - 180
8 204 266 029	white		(98 W)		40°
8 204 256 029	silver grey		warm white (3000 K)		9°

... .3. Luminaire with linear beam spread, horizontal

Monoflood 4 pole luminaire, linear beam spread, rotatable

Part number	Colour	Description	Luminous flux	Beam angle γ (FWHM)
8 204 246 079	black	Luminaire with external ribbed glass spreader lens, continuously adjustable through 360° from outside the luminaire	4720 lm	C 0 - 180
8 204 266 079	white			7°
8 204 256 079	silver grey			29°

Weight 7.5 kg

Monoflood 4 pole luminaire, medium wide beam

Part number	Colour	Weight	Light source	Luminous flux	Beam angle γ (FWHM)
8 204 246 049	black	6.9 kg	13 x LED 7.5 W	5192 lm	35°
8 204 266 049	white		(98 W)		
8 204 256 049	silver grey		warm white (3000 K)		

Part number Description

... .5 ... **Luminaire with neutral white colour temperature (4000 K)**

... .1 ... **Dimmable luminaire (DALI)**

Monoflood 4 RGBW pole luminaire, narrow beam

Part number	Colour	Weight	Light source	Luminous flux	Beam angle γ (FWHM)
8 204 249 019	black	7.2 kg	13 x LED module RGBW	max. 3481 lm	13°
8 204 269 019	white		W = 3000 K		
8 204 259 019	silver grey		(max. 105 W)		

Monoflood 4 RGBW pole luminaire, medium wide beam

Part number	Colour	Weight	Light source	Luminous flux	Beam angle γ (FWHM)
8 204 249 049	black	7.2 kg	13 x LED module RGBW	max. 2751 lm	35°
8 204 269 049	white		W = 3000 K		
8 204 259 049	silver grey		(max. 105 W)		

Monoflood 1, 2

Part number	Luminaire	Description
122 0 411 000	Monoflood 1	Honeycomb louvre , internal (factory fitted), to avoid glare
122 0 412 000	Monoflood 2	

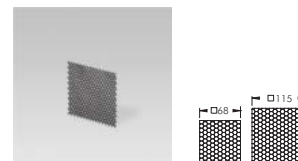

Monoflood 3, 4

Part number	Luminaire	Description
122 0 413 000	Monoflood 3	Honeycomb louvre , internal (factory fitted), to avoid glare
122 0 414 000	Monoflood 4	

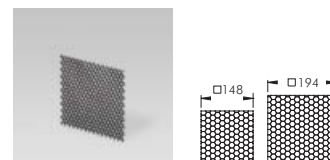

Monoflood 2, 3, 4 axially symmetrical wide beam

Part number	Luminaire	Description
122 0 397 940	Monoflood 2	Vertical louvre , stainless steel, to reduce lateral glare, internal (factory fitted)
122 0 398 940	Monoflood 3	
122 0 399 940	Monoflood 4	

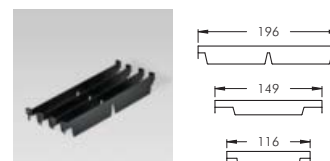

Monoflood 2, 3, 4 axially symmetrical wide beam

Part number	Luminaire	Description
122 0 440 940	Monoflood 2	Horizontal louvre , stainless steel, to reduce lateral glare, internal (factory fitted)
122 0 441 940	Monoflood 3	
122 0 442 940	Monoflood 4	

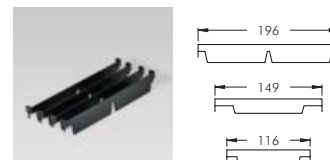

Monoflood 2, 3, 4 asymmetrical beam

Part number	Luminaire	Description
122 0 417 940	Monoflood 2	Vertical louvre , stainless steel, to reduce lateral glare, internal (factory fitted)
122 0 418 940	Monoflood 3	
122 0 419 940	Monoflood 4	

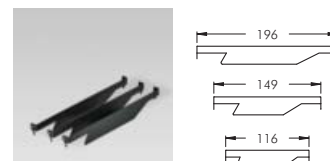

Monoflood 2, 3, 4

Part number	Luminaire	Description	Beam angle γ (FWHM)
			narrow beam
122 0 408 000	Monoflood 2	Prismatic glass , for diffused light distribution, internal (factory fitted)	12°
122 0 409 000	Monoflood 3		12°
122 0 410 000	Monoflood 4		12°

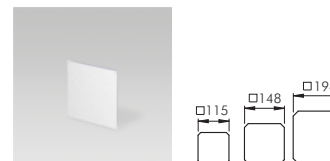

Dichroic colour filters are available upon request.



The internally fitted honeycomb louvre offers effective glare control and is protected from build up of dirt.



Monoflood 1

Part number	Colour	Description
122 0 401 940	black	Cowl , stainless steel, to avoid lateral glare, for retro-fitting
122 0 401 960	white	
122 0 401 950	silver grey	

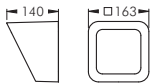

Monoflood 2

Part number	Colour	Description
122 0 402 940	black	Cowl , stainless steel, to avoid lateral glare, for retro-fitting
122 0 402 960	white	
122 0 402 950	silver grey	

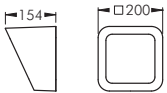

Monoflood 3

Part number	Colour	Description
122 0 403 940	black	Cowl , stainless steel, to avoid lateral glare, for retro-fitting
122 0 403 960	white	
122 0 403 950	silver grey	

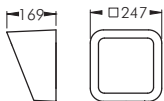

Monoflood 4

Part number	Colour	Description
122 0 404 940	black	Cowl , stainless steel, to avoid lateral glare, for retro-fitting
122 0 404 960	white	
122 0 404 950	silver grey	

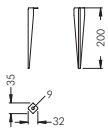

Monoflood 1

Part number	Colour	Description
129 0 731 940	black	Stainless steel earth spike , for use in landscape lighting
129 0 731 960	white	
129 0 731 950	silver grey	

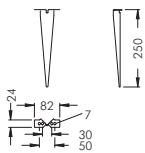

Monoflood 2

Part number	Colour	Description
129 0 502 940	black	Stainless steel earth spike , for use in landscape lighting
129 0 502 960	white	
129 0 502 950	silver grey	

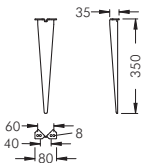

Monoflood 3, 4

Artikelnummer	Colour	Description
129 0 736 940	black	Stainless steel earth spike , for use in landscape lighting
129 0 736 960	white	
129 0 736 950	silver grey	

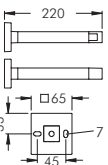

Monoflood 1

Part number	Colour	Description
128 0 738 940	black	Wall arm 220 mm , aluminium, polyester powder coated
128 0 738 960	white	
128 0 738 950	silver grey	

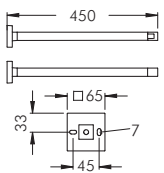

Monoflood 1

Part number	Colour	Description
128 0 739 940	black	Wall arm 450 mm , aluminium, polyester powder coated
128 0 739 960	white	
128 0 739 950	silver grey	

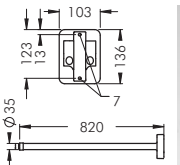

Monoflood 2, 3

Part number	Colour	Description
128 0 801 940	black	Wall arm 820 mm , aluminium, polyester powder coated, for illumination of signs and facades, cable duct inside, max. load 6,0 kg
128 0 801 960	white	
128 0 801 950	silver grey	

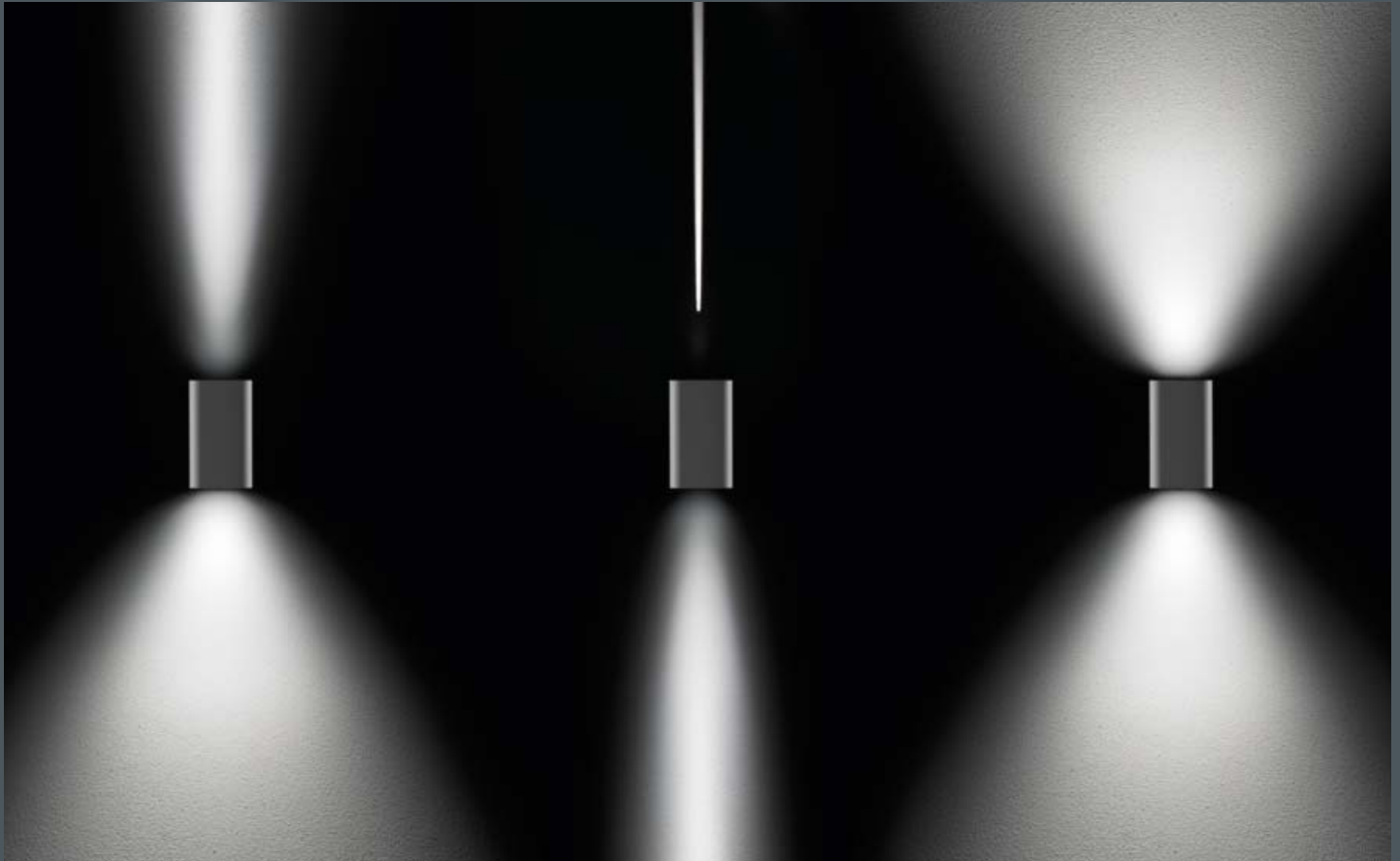

Highrise is a wall luminaire series with a two-sided light emission. There is a choice of different reflector options with narrow or wide beam light distributions. In addition, the version with a projector lens creates a very narrow, sharp-edged accent light. The combination of different optics for the up- and downward beam creates many different options for lighting design on façades.

Amplifier, Berlin
Lighting design:
Rosenspiess, Berlin
Photo: Koy+Winkel



Versions with asymmetrical or lateral wide beam light distributions are available to illuminate floor areas.



Highrise with two-sided light emission

With 2 high performance LED modules (Zhaga),
integral temperature monitoring device,
CRI: > 80, Colour tolerance: max. 3 SDCM
Service life: L80/B20 > 50 000 h
protection class I, IP65 , IK08
windage area AW 0.03 m²
corrosion-resistant die cast aluminium housing AlSi12,
polyester powder coated,
highly efficient aluminium reflectors,
all exterior steel parts are stainless steel,
tempered safety glass, silicon gasket,
wall box with 2 stainless steel screws:
2 drilled holes Ø 6 mm, spacing 150 mm,
2 cable entries for recessed or
surface mounted cable Ø 7 - 10 mm,
integral driver (AC/DC)

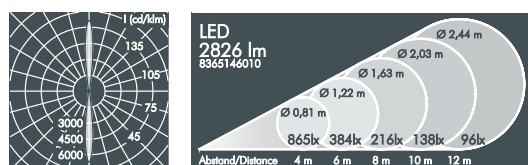
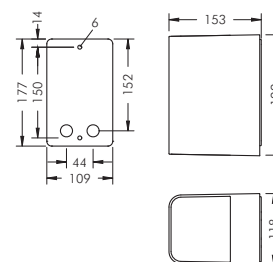

Highrise, narrow beam /narrow beam

Part number	Colour	Weight	Light source	Luminous flux	Beam angle γ (FWHM)	
8 365 146 019	black	2.8 kg	2 x LED module 18 W (36 W) warm white (3000 K)	2826 lm	up	down
8 365 166 019	white				10°	10°
8 365 156 019	silver grey					

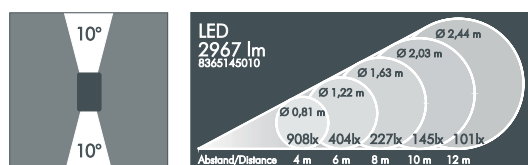

Part number	Colour	Weight	Light source	Luminous flux	Beam angle γ (FWHM)	
8 365 145 019	black	2.8 kg	2 x LED module 18 W (36 W) neutral white (4000 K)	2967 lm	up	down
8 365 165 019	white				10°	10°
8 365 155 019	silver grey					

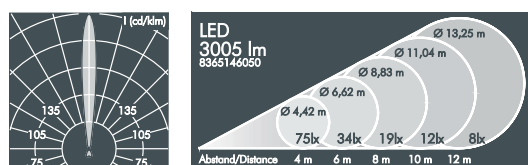

Highrise, narrow beam /wide beam

Part number	Colour	Weight	Light source	Luminous flux	Beam angle γ (FWHM)	
8 365 146 059	black	2.8 kg	2 x LED module 18 W (36 W) warm white (3000 K)	3005 lm	up	down
8 365 166 059	white				10°	58°
8 365 156 059	silver grey					

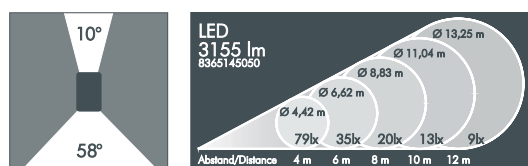

Part number	Colour	Weight	Light source	Luminous flux	Beam angle γ (FWHM)	
8 365 145 059	black	2.8 kg	2 x LED module 18 W (36 W) neutral white (4000 K)	3155 lm	up	down
8 365 165 059	white				10°	58°
8 365 155 059	silver grey					

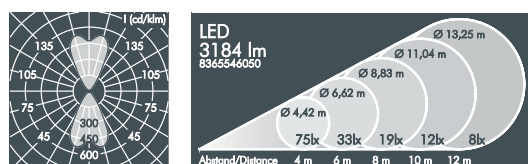

Highrise, wide beam /wide beam

Part number	Colour	Weight	Light source	Luminous flux	Beam angle γ (FWHM)	
8 365 546 059	black	2.8 kg	2 x LED module 18 W (36 W) warm white (3000 K)	3184 lm	up	down
8 365 566 059	white				58°	58°
8 365 556 059	silver grey					

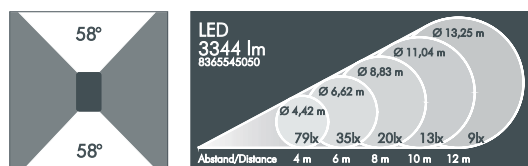

Part number	Colour	Weight	Light source	Luminous flux	Beam angle γ (FWHM)	
8 365 545 059	black	2.8 kg	2 x LED module 18 W (36 W) neutral white (4000 K)	3344 lm	up	down
8 365 565 059	white				58°	58°
8 365 555 059	silver grey					

Part number	Description
... 1 ..	Dimmable luminaire (DALI)

LED

Luminaires available in 2700 K and other colour temperatures upon request



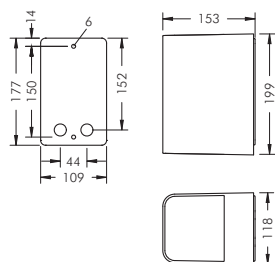

Highrise with two-sided light emission

With 2 high performance LED modules, integral temperature monitoring device, CRI: > 80, Colour tolerance: max. 3 SDCM Service life: L80/B20 > 50 000 h protection class I, IP65 , IK08 windage area AW 0.03 m²

corrosion-resistant die cast aluminium housing AlSi12, polyester powder coated, highly efficient aluminium reflector and projection lens, all exterior steel parts are stainless steel, tempered safety glass, silicon gasket, wall box with 2 stainless steel screws: 2 drilled holes Ø 6 mm, spacing 150 mm, 2 cable entries for recessed or surface mounted cable Ø 7 - 10 mm, integral driver (AC/DC)

Highrise, Accent light/narrow beam

Part number	Colour	Weight	Light source	Luminous flux	Beam angle γ (FWHM)	
8 365 646 019	black	2.8 kg	2 x LED module 16 W (32 W)	2019 lm	up	down
8 365 666 019	white				1°	10°
8 365 656 019	silver grey					

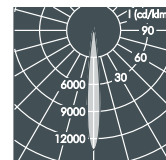
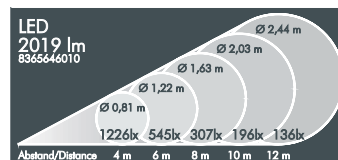

Part number	Colour	Weight	Light source	Luminous flux	Beam angle γ (FWHM)	
8 365 645 019	black	2.8 kg	2 x LED module 16 W (32 W)	2121 lm	up	down
8 365 665 019	white				1°	10°
8 365 655 019	silver grey					

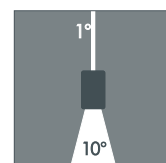
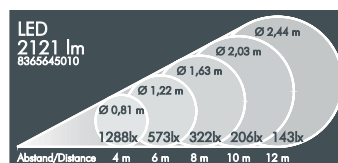

Highrise, Accent light/wide beam

Part number	Colour	Weight	Light source	Luminous flux	Beam angle γ (FWHM)	
8 365 646 059	black	2.8 kg	2 x LED module 16 W (32 W)	2198 lm	up	down
8 365 666 059	white				1°	58°
8 365 656 059	silver grey					

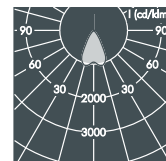
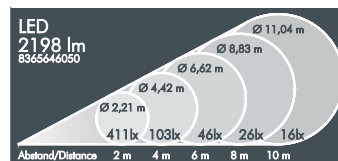

Part number	Colour	Weight	Light source	Luminous flux	Beam angle γ (FWHM)	
8 365 645 059	black	2.8 kg	2 x LED module 16 W (32 W)	2308 lm	up	down
8 365 665 059	white				1°	58°
8 365 655 059	silver grey					

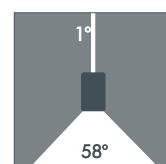
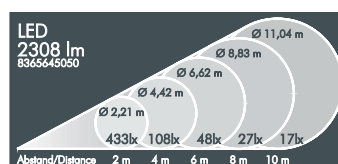

Highrise, Accent light/lateral wide beam

Part number	Colour	Weight	Light source	Luminous flux	Beam angle γ (FWHM)	
8 365 646 089	black	2.8 kg	2 x LED module 16 W (32 W)	1956 lm	up	down
8 365 666 089	white				1°	138°
8 365 656 089	silver grey					

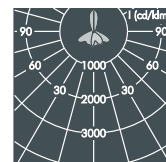
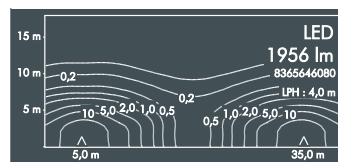

Highrise, Accent light/asymmetrical beam

Part number	Colour	Weight	Light source	Luminous flux	Beam angle γ (FWHM)	
8 365 646 099	black	2.8 kg	2 x LED module 16 W (32 W)	2176 lm	up	down
8 365 666 099	white				1°	60°
8 365 656 099	silver grey					

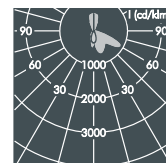
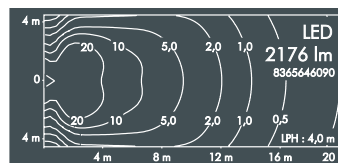

Part number	Description
. 5 . . .	Luminaire with neutral white colour temperature (4000 K)
. 1 . .	Dimmable luminaire (DALI)

LED

Luminaires available in 2700 K and other colour temperatures upon request



Highrise with two-sided light emission

With 2 high performance LED modules (Zhaga), integral temperature monitoring device, CRI: > 80, Colour tolerance: max. 3 SDCM
 Service life: L80/B20 > 50 000 h
 protection class I, IP65 , IK08
 windage area AW 0.03 m²
 corrosion-resistant die cast aluminium housing AlSi12, polyester powder coated, highly efficient aluminium reflectors and lens made of optical silicon, all exterior steel parts are stainless steel, tempered safety glass, silicon gasket, wall box with 2 stainless steel screws: 2 drilled holes Ø 6 mm, spacing 150 mm, 2 cable entries for recessed or surface mounted cable Ø 7 - 10 mm, integral driver (AC/DC)

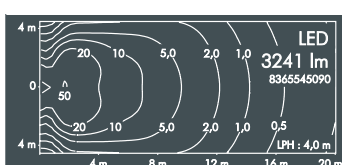
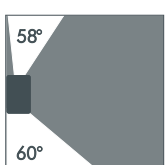
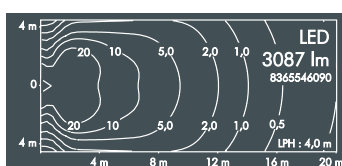
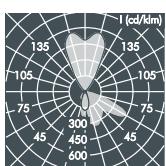
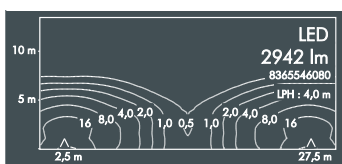
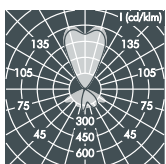
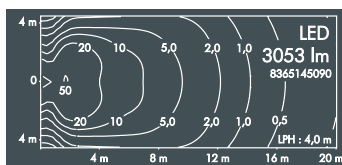
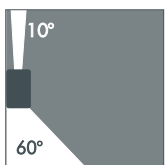
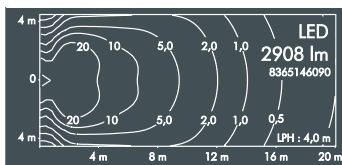
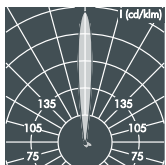
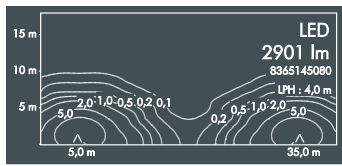
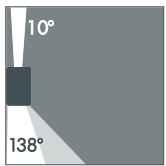
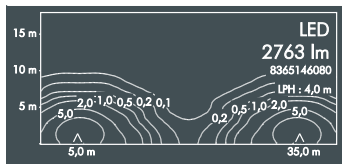
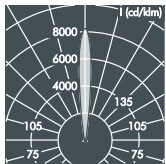
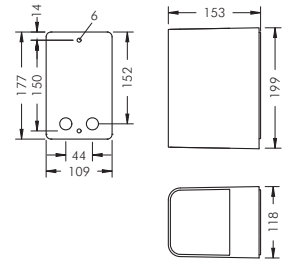

Highrise, narrow beam/lateral wide beam

Part number	Colour	Weight	Light source	Luminous flux	Beam angle γ (FWHM)	
8 365 146 089	black	2.8 kg	2 x LED module 18 W (36 W) warm white (3000 K)	2763 lm	up	down
8 365 166 089	white				10°	138°
8 365 156 089	silver grey					

Part number	Colour	Weight	Light source	Luminous flux	Beam angle γ (FWHM)	
8 365 145 089	black	2.8 kg	2 x LED module 18 W (36 W) neutral white (4000 K)	2901 lm	up	down
8 365 165 089	white				10°	138°
8 365 155 089	silver grey					

Highrise, narrow beam/asymmetrical beam

Part number	Colour	Weight	Light source	Luminous flux	Beam angle γ (FWHM)	
8 365 146 099	black	2.8 kg	2 x LED module 18 W (36 W) warm white (3000 K)	2908 lm	up	down
8 365 166 099	white				10°	60°
8 365 156 099	silver grey					

Part number	Colour	Weight	Light source	Luminous flux	Beam angle γ (FWHM)	
8 365 145 099	black	2.8 kg	2 x LED module 18 W (36 W) neutral white (4000 K)	3053 lm	up	down
8 365 165 099	white				10°	60°
8 365 155 099	silver grey					

Highrise, wide beam/lateral wide beam

Part number	Colour	Weight	Light source	Luminous flux	Beam angle γ (FWHM)	
8 365 546 089	black	2.8 kg	2 x LED module 18 W (36 W) warm white (3000 K)	2942 lm	up	down
8 365 566 089	white				58°	138°
8 365 556 089	silver grey					

Highrise, wide beam/asymmetrical beam

Part number	Colour	Weight	Light source	Luminous flux	Beam angle γ (FWHM)	
8 365 546 099	black	2.8 kg	2 x LED module 18 W (36 W) warm white (3000 K)	3087 lm	up	down
8 365 566 099	white				58°	60°
8 365 556 099	silver grey					

Part number	Colour	Weight	Light source	Luminous flux	Beam angle γ (FWHM)	
8 365 545 099	black	2.8 kg	2 x LED module 18 W (36 W) neutral white (4000 K)	3241 lm	up	down
8 365 565 099	white				58°	60°
8 365 555 099	silver grey					

Part number	Description
..... 5 ...	Luminaire with neutral white colour temperature (4000 K)
..... 1 ..	Dimmable luminaire (DALI)

LED

Luminaires available in 2700 K and other colour temperatures upon request





Unit is a new wall luminaire for the uniform illumination of floor areas adjacent to buildings. The clean housing design allows the luminaires to be used in various different architectural environments. There is a choice between an asymmetrical light distribution for area lighting and a lateral wide beam distribution for lighting of floor areas along façades. Alternatively, the luminaire can be used as an uplight for the illumination of ceilings or canopies.



Unit creates uniform illumination on floor areas adjacent to buildings – alternatively with asymmetrical or lateral wide beam light distributions.

Unit with one-sided light emission

With 2 highly efficient LED modules,
integral temperature monitoring device,
CRI: > 80, Colour tolerance: max. 3 SDCM
Service life: L80/B20 > 50 000 h
protection class I, IP65 , IK08
windage area AW 0.057 m²
corrosion-resistant die cast aluminium housing AlSi12,
polyester powder coated,
highly efficient reflector,
all exterior steel parts are stainless steel,
tempered safety glass, silicon gasket,
wall box with 2 stainless steel screws:
2 drilled holes Ø 7 mm, spacing 214 mm,
4 cable entries for recessed or
surface mounted cable Ø 7 - 10 mm,
integral driver (AC/DC)

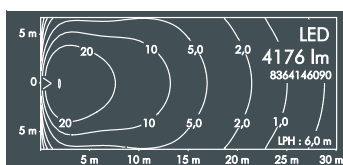
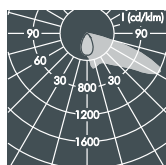
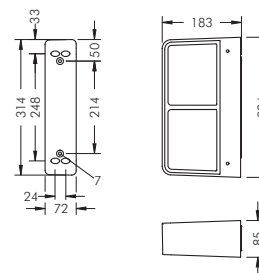

Unit, asymmetrical beam

Part number	Colour	Weight	Light source	Luminous flux	Main beam angle γ
8 364 146 099	black	3.3 kg	2 x LED module 18.5 W (37 W) warm white (3000 K)	4176 lm	63°
8 364 166 099	white				
8 364 156 099	silver grey				

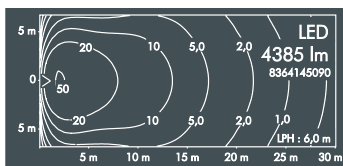
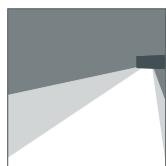

Part number	Colour	Weight	Light source	Luminous flux	Main beam angle γ
8 364 145 099	black	3.3 kg	2 x LED module 18.5 W (37 W) neutral white (4000 K)	4385 lm	63°
8 364 165 099	white				
8 364 155 099	silver grey				

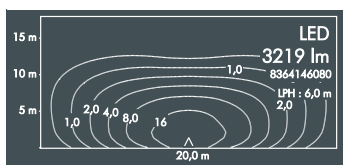
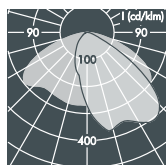

Unit, lateral wide beam

Part number	Colour	Weight	Light source	Luminous flux	Beam angle γ (FWHM)	
8 364 146 089	black	3.3 kg	2 x LED module 18 W (36 W) warm white (3000 K)	3219 lm	C 0 - 180	C 90 - 270
8 364 166 089	white				62°	142°
8 364 156 089	silver grey					

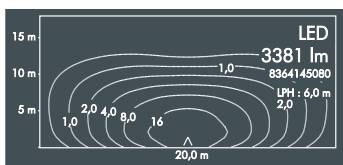

Part number	Colour	Weight	Light source	Luminous flux	Beam angle γ (FWHM)	
8 364 145 089	black	3.3 kg	2 x LED module 18 W (36 W) neutral white (4000 K)	3381 lm	C 0 - 180	C 90 - 270
8 364 165 089	white				62°	142°
8 364 155 089	silver grey					

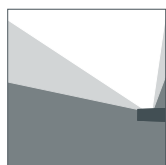

Alternatively, the luminaires can be used as uplights for indirect illumination.

Part number	Description
... .. 1 ..	Dimmable luminaire (DALI)

Accessories Unit, Louvre (internal, factory fitted, no retro-fitting)	
123 0 516 940	Unit asymmetrical beam, vertical louvre, stainless steel, to reduce lateral glare
123 0 517 940	Unit lateral wide beam, horizontal louvre, stainless steel, to reduce glare



For Unit there is a choice of two different reflector options – an asymmetrical distribution for area lighting and a lateral wide beam distribution for uniform illumination of floor areas along façades.

LED

Luminaires available in 2700 K and other colour temperatures upon request

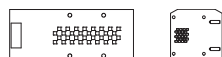



Willy Meyer+Sohn GmbH+Co. KG
Stemmessiepener Weg 5
58675 Hemer
Germany
Phone: +49 2372 9891-0
Fax: +49 2372 9891-48
E-mail: info@meyer-lighting.com
www.meyer-lighting.com

