



# TARUS 400

*The pictures shown are for illustrative purposes only. For shape, material and color specifications refer to internal descriptions.*

# Tarus 400

## Technical data

### INSTALL

Large areas, sports fields, sports facilities, industrial contexts.

### ACCESSIBILITY



#### Openable

Openable fixture with basic tools  
Replaceable internal components  
using basic tools.

### OPTICAL TECHNOLOGY



#### Glassed

Refracting optical system consist of singlechip LED, PMMA lenses with 30 years of warranty against UV and yellowing by aging, aluminium reflector having a purity of 99,7% and extra clear tempered glass.

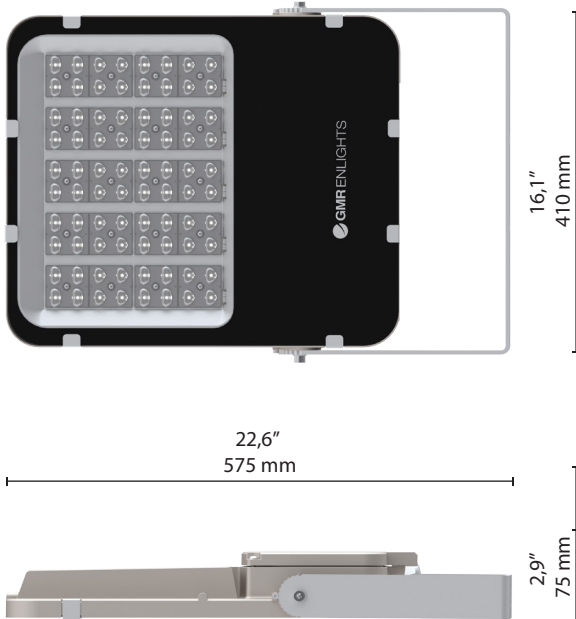

Scale: 1:10

#### Max. weight

9 Kg

#### CXS

Front: 0,17 m<sup>2</sup>

### STANDARD

EN 60598-1, EN 60598-2-3, EN 62471, EN 55015, EN 61547, EN 61000-3-2, EN 61000-3-3

### CONFORMITY | PROTECTION

#### Conformity



#### Salt spray test

ISO 9227



8000 hr

#### Vibration test passed

IEC 60068-2-6



#### Insulation classes



#### Protection classes



#### Photobiological safety



Classe 0 Exempt group IEC/TR62471

### PLUS



CUT OFF



OPTICAL FLEXIBILITY



LOW GLARE



CAM 2017 COMPLIANT



A++ IPEA MIN

### LIGHTING FIXTURE FEATURES

#### General features

|                               |  |
|-------------------------------|--|
| Power source:                 | 220-240V   50/60Hz   tolerance +/-10%  |
| Current supply:               | 350 mA   525 mA   700 mA   1050 mA (P <sub>max</sub> = 266W)                   |
| Power Factor   THD:           | ≥0.95   <10 % (At full load)   |
| Expected life (Ta=25°):       | > 100.000 h   L90B10   @ LED 1050mA  |
| Operational temperature (Ta): | T <sub>min</sub> = -40°C   T <sub>max</sub> = +55°C   700 mA<br>+50°C   1050mA |
| Storage temperature:          | -40°C/+80°C  |
| Overcharge protection:        | Main surge immunity up to 10kV   |
| Disconnecter:                 | Optional   |
| Standard functions:           | Current fixed   Virtual midnight   CLO   |

#### Materials

|                   |   |
|-------------------|---|
| Lighting fixture: | Die cast aluminium   EN1706   |
| Optical system:   | Optics in PMMA<br>Aluminium reflector, 99,7% oxidised and polished purity |
| Screen:           | Screen-printed ultraclear tempered glass   Th. 4mm                        |
| Gaskets:          | Removable silicon   |
| Cable gland:      | Polyamide PA66   PG16   Ø 14mm MAX   IP 66                                |
| Screws and bolts: | AISI 304 stainless steel  |
| Bracket:          | Galvanized steel  |
| Fixture color:    | GMR light   |
| Silkscreen color: | RAL 9005  |

### LED FEATURES

|                           |  |
|---------------------------|--|
| LED data 4.000 K - 700mA: | 340 lm/LED   180 lm/W   25°C [Tj]   ≤ 3 step MacAdam |
| Color temperature:        | 3.000 K   4.000 K   5.700 K   CRI ≥ 70               |

### FIXING TYPE

5° step seamless tilt adjustment

#### Pole-top

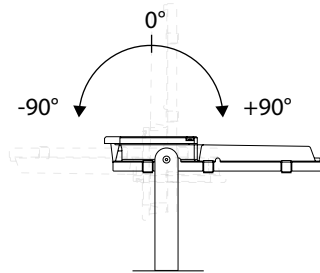

#### Wall mounting

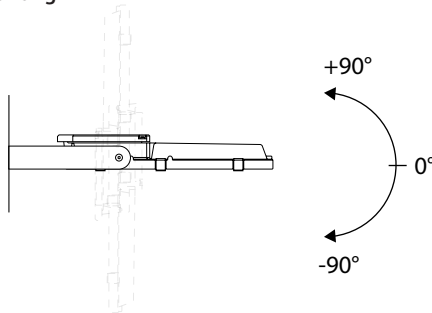

#### Surface mounting

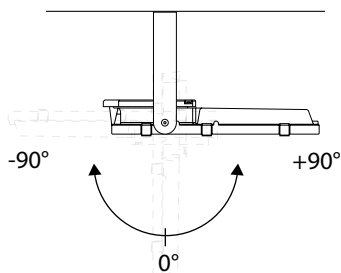

### BRACKET DRILLING

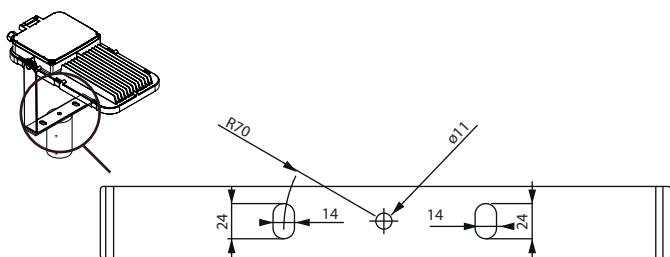

### OPTIONAL

**Mechanical equipment:** Hot galvanized steel pole-top cross arm  
Galvanized protection grid

**Additional surge protector device:** SPD with warning LED CLASS 1 | CLASS 2 12kV/kA

**Additional surge protector device SPD 400:** SPD with warning LED CLASS 1 | CLASS 2 12kV+ permanent overvoltage protection higher than 270Vac

**Electrical equipment:** 0,5 m power cable with 2-3 or 4-5 core connector  
Disconnecter and cable clamp | cross section 1.5mm<sup>2</sup> ÷

**Optional functions:** 4mm<sup>2</sup>  
DALI-DALI2 | DALI SENSOR

**Connectors and sockets:** NM (Nema Socket ) | LM (Lumawise Zhaga Socket)

### FOCUS: CROSS-ARM

Fixing systems on cross-arm for pole-top installation.

Tarus is a versatile floodlight: the adjustable bracket and the accessories for pole-top fixing make it configurable, according to the specific lighting project.

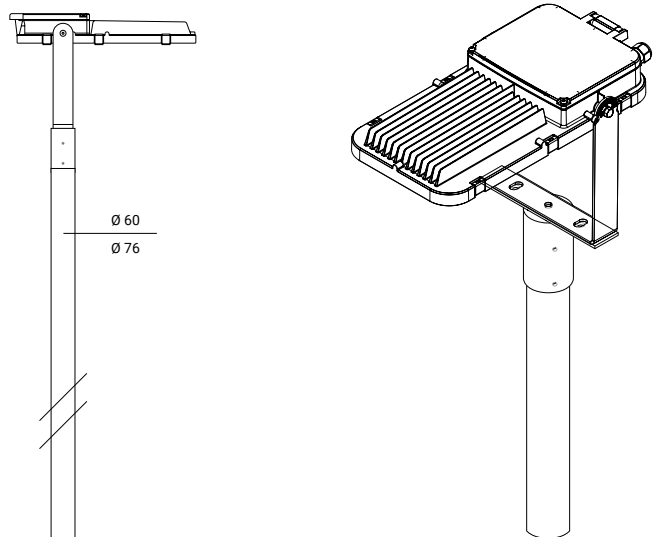

### MODULES

Crossbeam available for installation from 1 to 4 Tarus (\*)

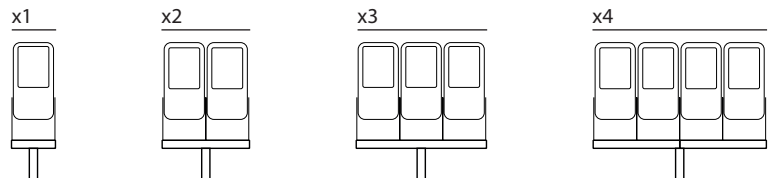

<sup>(\*)</sup>The icons are demonstrative. The actual dimensions and distances between the products are to be checked at time of order.

2A

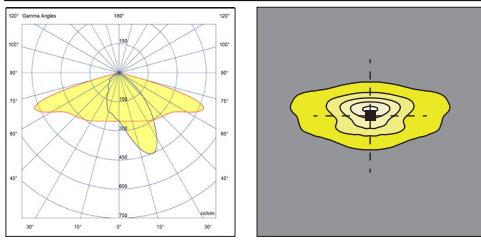

11A

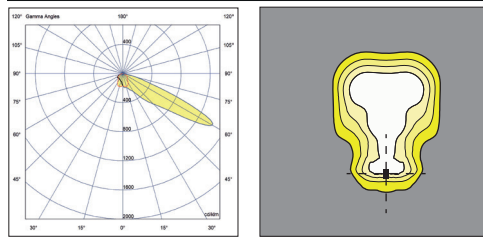

3C

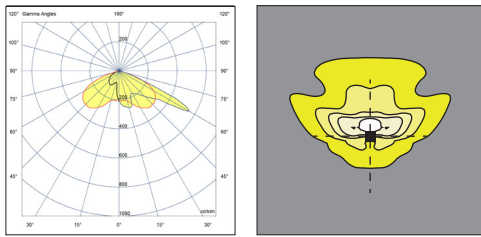

11B

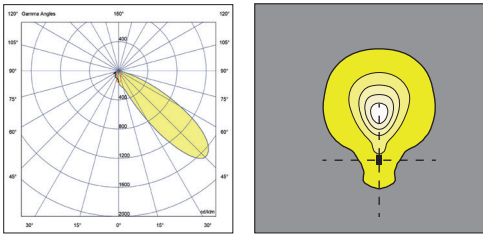

5A

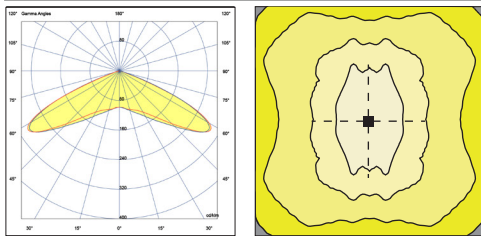

11C

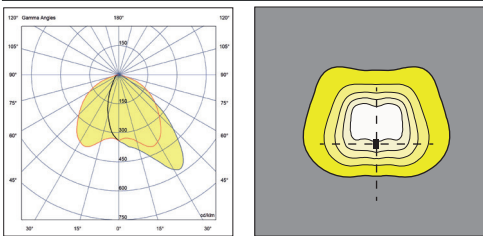

9A

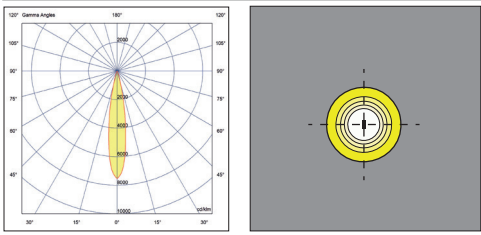

11E

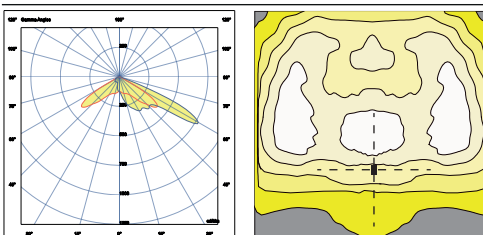

9B

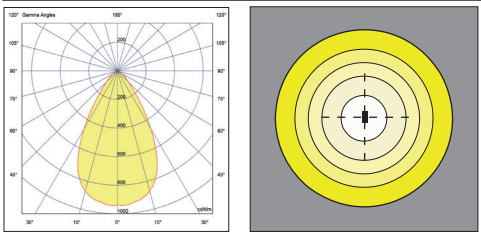

11F

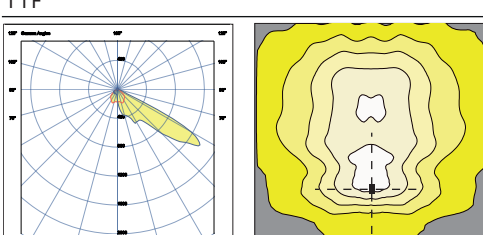



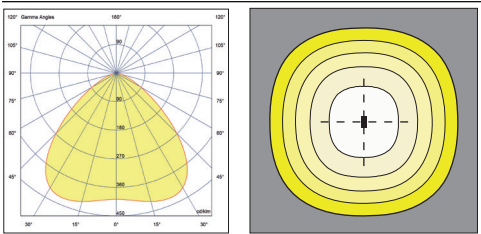

9C

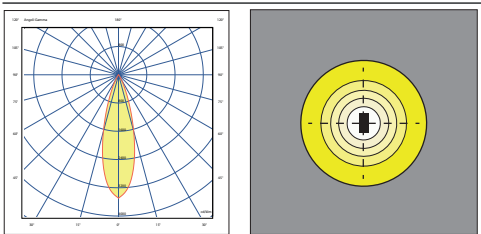

9E



The LED modules nominal data refers only to the LED light sources in a standard version, with 4000 K color temperature, color rendering index CRI 70 min. and a junction temperature  $t_j$  of 25°C. The LED nominal data are extrapolated from the manufacturer documentations.

| LED code |   | (*)<br>I [mA] | Luminous flux [lm] | Power [W] | Efficiency [lm/W] |
|----------|---|---------------|--------------------|-----------|-------------------|
| GL16     |  | 350           | 12821              | 63,7      | 201               |
|          |   | 525           | 18014              | 97,1      | 186               |
|          |  | 700           | 22620              | 127,9     | 177               |
|          |   | 1050          | 30535              | 196,9     | 155               |
| GL20     |  | 350           | 15873              | 79,2      | 200               |
|          |   | 525           | 22296              | 121,4     | 184               |
|          |  | 700           | 27991              | 159,6     | 175               |
|          |   | 1050          | 35505              | 245,2     | 145               |

The lighting fixture measured data refers to GMR ENLIGHTS products in a standard version, with 4000 K color temperature, optica type 9A and an ambient temperature  $t_a$  of 25 °C.

**GMR ENLIGHTS offers the possibility of driving the device with custom currents (\*).**

Feature availability is subject to configurations. To obtain luminous fluxes and efficiencies of the lighting fixture in case of optic type and/or color temperature and/or color rendering index different from the standard use the conversion factors shown in the tables.

| Order code: TA4_GLxx |  | (*)<br>I [mA] | Luminous flux [lm] | Power [W] | Efficiency [lm/W] |
|----------------------|--|---------------|--------------------|-----------|-------------------|
| GL16                 |  | 350           | 11395              | 70,0      | 162               |
|                      |  | 525           | 16010              | 105,5     | 151               |
|                      |  | 700           | 20104              | 139,0     | 144               |
|                      |  | 1050          | 27139              | 214,0     | 126               |
| GL20                 |  | 350           | 14108              | 87,0      | 162               |
|                      |  | 525           | 19817              | 132,0     | 150               |
|                      |  | 700           | 24878              | 173,5     | 143               |
|                      |  | 1050          | 33239              | 266,5     | 125               |

### OPTIC CONVERSION FACTOR LUMINOUS FLUX

| Optic type                      | Flux multiplier |
|---------------------------------|-----------------|
| 2A   3C   11A   11B   11E   11F | 0,98            |
| 5A   9A   9E                    | 1,00            |
| 9B   9C   11C                   | 0,99            |

### Tk CONVERSION FACTOR LUMINOUS FLUX

| Tk [K] | Flux multiplier |
|--------|-----------------|
| 3.000  | 0,94            |
| 5.700  | 1,01            |

### CRI CONVERSION FACTOR LUMINOUS FLUX

| CRI (color render index) | Flux multiplier |
|--------------------------|-----------------|
| 70                       | 1,00            |
| 80                       | 0,93            |

(\*) See pag: Available optical system, to check the optic type availability.

(\*\*) See pag: Technical data, to check the colour temperature availability.

# Functions

## Standard functionality

### Fixed current

During production, the light fixture is pre-set with a fixed current amongst the standard settings that appear in the tables on page 3. Upon customer's request, it is also possible to set a specific current (custom setting).

### Virtual Midnight | Automatic dimming

The driver is programmed to automatically dim the light output according to the time. As required by regulations, the maximum output is set during initial hours and towards the end of the light fixture's operating time interval. During these hours there is statistically more traffic. The light output is then dimmed during the central hours of the operating time interval. This management is achievable through a self-learning process of the device, that establishes the centre point of the time interval. This moment is called "virtual midnight" and it is the point that the dimming profile refers to in order to know when to reduce the light output. We can manage up to 8hrs of programming that evolve around the virtual midnight and up to 5 steps of dimming. This way the light output will adjust automatically, adapting throughout the year to the duration of the nighttime, by referring to the pre-set parameters based on the centre point of the operating time interval.

### CLO Constant Lumen Output

LEDs over time are inevitably subject to performance depreciation. This light reduction may be compensated by gradually increasing the LED's current during its lifespan, this corresponds to a gradual increase of lumen output proportional to the amount that is naturally depreciated.

## On request functionality

### DALI - DALI2 Control and monitoring system

On request, the fixture can be fitted with a DALI2 communication interface. This protocol allows it to be monitored and controlled remotely through use of Dali control buses.

### DALI SENSOR (D4i)

On request, the fixture can be equipped with a D4i certified power supply. This is the ideal solution for wireless sensors and/or controls. This system was developed to integrate various systems to address smart city requirements. Included is DALI2 protocol + auxiliary power (AUX) to supply power to devices and sensors. This system is usually required when using a Zhaga Lumawise socket.

### LINESWITCH

This functionality by using an extra wire within the streetlight's power line, allows to dimmer to a pre-set level. For example, a centralised timer can change this value from 100% to 50%, and vice versa.

### AMPDIM

This feature allows dimming using the power line controlled by an upstream flow regulator. For this feature, the flow controller must use amplitude modulation (AM).

### NEMA | Nema Socket (7 PIN)

The Nema Socket is a 7 PIN connector/socket with IP66 rating, that is fitted on the fixture to make it interfaceable with various ANSI C136 compliant devices and remote-control gear. These devices can be installed during or after installation of the light fixtures. The NEMA socket can provide power interruption and is interfaceable with DALI buses and/or 1-10V dimming. It is compatible with point-to-point node connection, and twilight sensors ect.

### ZHAGA Lumawise Zhaga Socket (4 PIN)

The Lumawise Zhaga socket is a small and compact 4 Pin connector/socket, that fits ideally with the design of GMR ENLIGHTS fixtures. With ZHAGA Lumawise sockets it is possible install the devices, sensors, ZHAGA remote controls during or after installation of the light fixtures. This socket is usually required in conjunction with the DALI Sensor feature, which involves a DALI2/D4i communication protocol in addition to 12/24V auxiliary port to supply power to the sensors. It is compatible with point-to-point wireless control solutions and SMART CITY applications to control and monitor the public lighting infrastructure.

### REMOTE CONTROL ZHAGA STD

The device is installed on the lighting body equipped with D4i driver, via a prepared zhaga socket. The remote control works at 2.4GHz frequencies, and communicates in a secure mesh network thanks to 256bit data encryption. Thanks to the better positioning of the antenna, the node allows you to cover large distances and overcome obstacles. Equipped with lux meter and accelerometer, it can work both stand-alone and within the dedicated communication infrastructure. The device implements energy saving policies that bring the average consumption to 0.19W. In the smartcity application, the node allows you to interact with the street lighting network, dimming the lighting fixtures as needed and based on traffic and weather conditions, bringing significant economic advantages to the system in terms of energy savings. The node also allows monitoring and diagnostics of the public lighting network, from a single area, to the country up to an entire city or region. The knot has a diameter of 80mm and a height of 59mm. IK09, IP66.

### ZHAGA GPS REMOTE CONTROL

In addition to the functionality expressed for the STD version, this version also includes a GPS. Thanks to GPS, the system can count on an astronomical clock as well as all the functions related to the exact positioning of the lighting body. Especially in the installation and commissioning phase, having the information relating to the positioning available simplifies and significantly speeds up the start-up of the system.

### Third-party remote control

GMR ENLIGHTS fixtures are compatible with most third-party remote controls, powerline communication systems, wired systems (buses) and wireless systems.

### Example of 4-step adjustment with virtual midnight

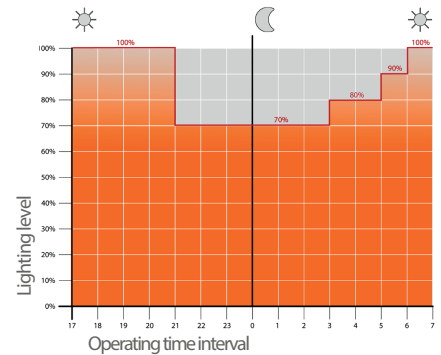

### CLO Light Flow Compensation

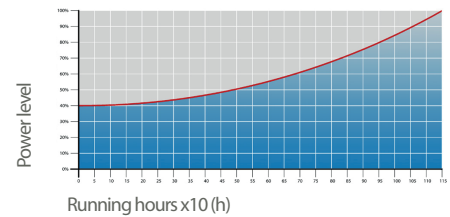

### 7 Pin Nema Socket 7 (A) and IP66 shorting cap (B)

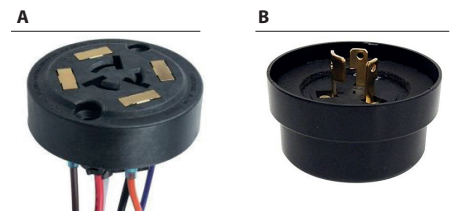

### 4 Pin Lumawise Zhaga Socket (C) and IP66 cap (D)

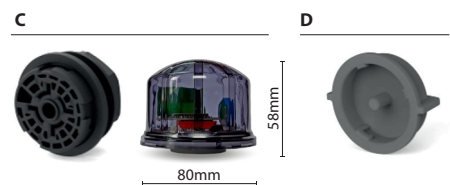

### Installation example of Lumawise Zhaga



## Protection cycles

GMR ENLIGHTS works with cast iron, steel and aluminum. The materials are selected and processed to maximize performance and quality.

### GALVANIZED STEEL

#### Protection of galvanized steel surfaces for poles

The protection of galvanized steel elements is achieved by following steps:

- Micro sandblasting;
- First epoxy layer application followed by: Wilting > Drying > Cooling;
- Acrylic glaze layer application followed by: Wilting > Drying > Cooling;
- Packing at least after 24-hour-drying at room temperature.

#### Protection of galvanized steel surfaces for brackets and pastorals

The protection of the galvanized steel elements is achieved thanks to:

- Micro sandblasting;
- Phosphoric pickling bath at a ph level ranging from 1.5 to 3;
- Rinsing with demineralised water;
- First powder layer application;
- Kiln firing;
- Application of a final powder layer;
- Kiln roasting of the final powder layer at 180°C (356°F);
- Cooling.

### CAST IRON

#### Protection of cast iron surfaces for bases

The protection of cast iron elements is achieved by the following treatments:

- Surface micro shotblasting;
- Mono-component dip galvanizing followed by: Wilting > Drying > Cooling;
- Epoxy micaceous primer application followed by: Wilting > Drying > Cooling;
- Acrylic enamel application followed by: Wilting > Drying > Cooling;
- Packing at least after 24-hour-drying at room temperature.

### DIE-CAST ALUMINIUM

#### Protection of die-cast aluminium surfaces for lighting fixtures, tops, collars, brackets and pastorals

Lighting fixtures, brackets, pastoral, and die-cast accessories undergo a cycle of powder painting which creates a barrier against the corrosion of metal parts. Moreover this barrier makes the finished product comply with design specifications in terms of surface roughness, color and reflectance.

The cycle consists of the following steps:

- Micro sandblasting;
- Hot pickling bath in a zinc-based phosphodegreasing solution;
- Specific process for the preparation of surfaces before painting;
- Washing with water;
- Rinsing with demineralised water and subsequent drying;
- First powder layer application followed by kiln baking at 180°C (356°F);
- Final powder layer application using a High Durability product and final kiln roasting at 180°C (356°F).



#### Salt spray test

The top quality of such treatments is confirmed by salt spray tests performed in accordance with standard ISO 9227:2017 Neutral Salt Spray test (NSS).

The test was carried out for 8.000 hours at 35°C (95°F) and demonstrated through the report test released.



**GMR ENLIGHTS s.r.l.**

Legal headquarters:  
Strada Provinciale Specchia - Alessano, 68 • 73040 (LE)

Administrative and operational headquarters:  
Via Grande n°226 • 47032 Bertinoro (FC)

T +39 0543 462611  
F +39 0543 449111

[sales@gmrenlights.com](mailto:sales@gmrenlights.com)  
[www.gmrenlights.com](http://www.gmrenlights.com)