

PPAD-C-HB-DALI-ADDR

Ceiling mounted, high bay DALI addressable presence detector

Key Features

- PIR Sensor: Detects movement within the unit's detection range, allowing load control in response to changes in occupancy.
- Light Level Sensor: Measures the overall light level in the detection area.
- Status LEDs.
- Connection to DALI network for power and communication.
- Adjustable mask (supplied) for limiting beam direction.



Achievable Energy Savings

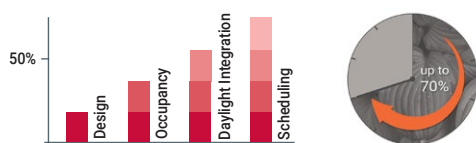

Code Compliance

- Improves BREEAM & LEED scoring for building sustainability.
- Contributes to energy reduction targets under Climate Change Levy (CCL) and Carbon Reduction Commitment (CRC).
- Qualifies for Enhanced Capital Allowance (ECA) applications.
- Delivers lighting control requirements under UK Building Regs - L2a & L2b and BRE: 498.

Overview

The PPAD-C-HB-DALI-ADDR is a ceiling mounted, fully addressable DALI passive infrared PIR presence/absence detector designed to be part of the iLight Series DALI network*.

PPAD-C-HB-DALI-ADDR is a high sensitivity PIR detector suitable for high bay applications, such as warehouses and factories, and where high detection sensitivity is needed.

Functioning as a presence detector, the unit returns occupancy data to the DALI network.

The photocell provides a lux level measurement value to the DALI network.

Detection

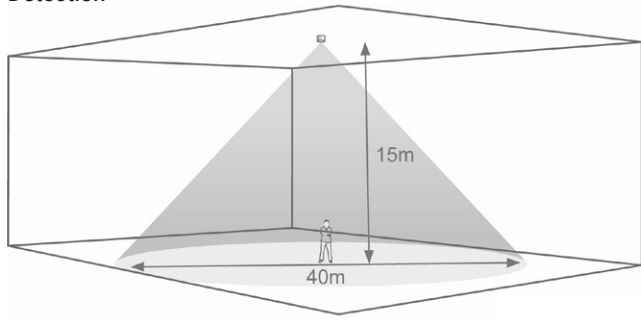

Ideal for warehouses, atriums and high bay applications where daylight harvesting and minimum light levels are required.

Maximum recommended mounting height: 15m

Technical Specifications

Weight: 0.10kg

Supply Voltage: 9.5VDC–22.5VDC via DALI

Supply Current 8mA

Terminal Capacity: 2.5mm² (solid or stranded)

Temperature: -10°C to 35°C

Humidity: 5 to 95% non-condensing

Material (casing): Flame retardant ABS and PC/ABS

IP rating: 40 without gasket. 65 with gasket.(Supplied)

Compliance: EMC-EMC-2014/30/EU
LVD-2014/35/EU

Accessories

- SB-C: Surface Mounting Box
- SB-C-EX: Surface Mounting Box Extender
- SB-C-IP65: IP65 Rated Surface Mounting Box



SB-C: Surface Mounting Box



SB-C-EX: Surface Mounting Box Extender



SB-C-IP65: IP65 Rated Surface Mounting Box

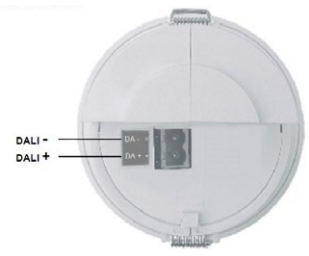
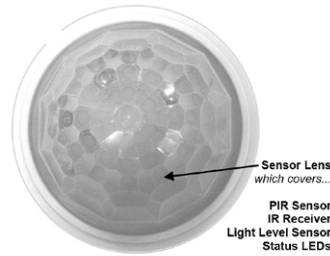

Dimensions

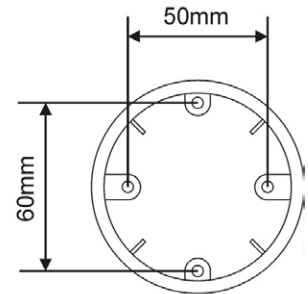
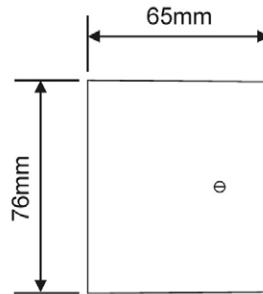
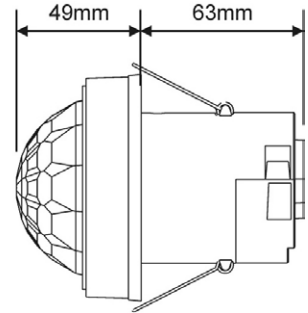
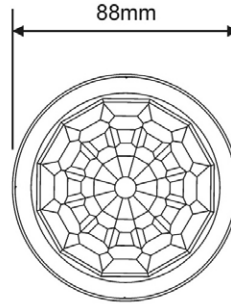

Commissioning

*This sensor is intended for use with iLight DALI controllers (Using SCMD4 or SCMD2). Commissioning is done when addressing devices on the DALI line.

Contact Us

enquiries@iLight.co.uk

www.iLight.co.uk

iLight
A brand of Signify
Usk House, Llantarnam Park
Cwmbran, NP44 3HD, UK

Changes to the products, to the information contained in this document, and to prices are reserved; so are errors and omissions.

© 2024 Signify Holding
All Rights Reserved

iLight is a registered trademark.
All other trademarks are property of their respective owners.

PPAD-C-HB-DALI-ADDR Rev9 0124



FM 727924