

TECHNOLOGY



Heat Sense

Automatically reduces LED power at high temperatures, ensuring longevity and safety in Filix products.



Flow Sense

A built-in protector against power-related issues, ensuring lasting performance and safety.



Split & Seal

Uses protective polymers to shield Filix products from water and moisture, boosting durability and resilience.

Arpool XS





Arpool XS

Specification Sheet



IP68

ISO 9227:2017 Salt Spray tested for 500 hours

LUMINAIRE FEATURES

Design and Application

- Small pools and medium pools
- Fountains and water features

Mechanical details

- IK10 crystal-clear tempered glass, 10mm (0.39") thick
- IP68, rated for permanent submersion
- Maximum installation depth up to 5m (16')
- AISI316L stainless steel body
- Suitable for chlorine and marine environments
- Supplied with 3m(10') oil and water resistant feed cable as standard
- Press-fit installation

Electrical details

- LED Lifetime TM-21 @ 105°C
L80(24K) = 145,000 hours
- Operating temperature: -20°C (-28°F) to +50°C (122°F)
- LED CRI: >85
- Remote power supply
- Low voltage operation

Sustainability

- 87% Recyclable

Controls

- DMX, with compatible LED power supply
- DALI, with compatible LED power supply
- 0-10V, with compatible LED power supply
- Mains, with compatible LED power supply

Integrated systems

- Split & Seal
- Heat Sense
- Flow Sense

Links & Downloads

- [List of available drivers](#)
- [Voltage drop calculator](#)
- Fixure installation manual
- Housing installation manual
- CAD file
- IES-LTD data

Note

Underwater luminaire – must be constantly submersed.



Arpool XS

ORDERING INFORMATION

MODEL	
AXS	
APPLICATION	
TM	<ul style="list-style-type: none">• TM - Ø45mm x H-95mm (Ø1,77" x H-3,7")
POWER	
L	<ul style="list-style-type: none">• L - 3W, 2700/4000K, 250 lm• L - 3W, RGBW (W 4000K)• L - 3W, TW (2200K-4000K)
COLOR TEMP.	
27	<ul style="list-style-type: none">• 27 - 2700K
30	<ul style="list-style-type: none">• 30 - 3000K
40	<ul style="list-style-type: none">• 40 - 4000K
RGBW	<ul style="list-style-type: none">• RGBW (W 4000K)
TW	<ul style="list-style-type: none">• TW - Tunable white 2200K-4000K
OPTICS	
SP	<ul style="list-style-type: none">• SP - Spot 15°
FL	<ul style="list-style-type: none">• FL - Flood 40°
W	<ul style="list-style-type: none">• W - Wide 70°
SPX	<ul style="list-style-type: none">• SPX - Spot 15° + Hex
FLX	<ul style="list-style-type: none">• FLX - Flood 40° + Hex
WX	<ul style="list-style-type: none">• WX - Wide 70° + Hex
INPUT TYPE	
CC	<ul style="list-style-type: none">• CC - 350mA constant current
OPTIONS	
3	<ul style="list-style-type: none">• 3 - Standard feed cable 3m (10')
6	<ul style="list-style-type: none">• 6 - Luminaire supplied with 6m (20') feed cable
9	<ul style="list-style-type: none">• 9 - Luminaire supplied with 9m (30') feed cable
20	<ul style="list-style-type: none">• 20 - Luminaire supplied with 20m (65') feed cable
GLARE CONTROL	
1	<ul style="list-style-type: none">• 1 - Half Moon



Arpool XS

MANDATORY ACCESSORIES

Housings

HOUSING
TAXS

- AXS - Technopolymer installation housing

Power supplies

DRIVERS
[LINK](#)

- List of available drivers



Arpool XS

INSTALLATION DETAILS

Fixture

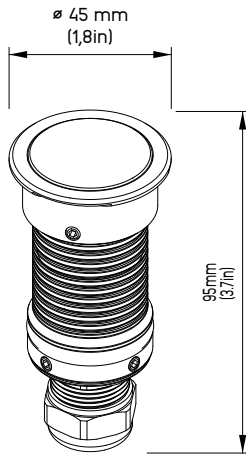

Made out of AISI316l stainless steel with additional passive coating, this luminaire is suitable for use in marine and chlorine environments. The standard luminaires are equipped with water and oil-resistant cables in various standard lengths. With integrated systems such as Flow Sense, Heat Sense, and Split & Seal, the luminaire has all the needed protective barriers.

Installation housing

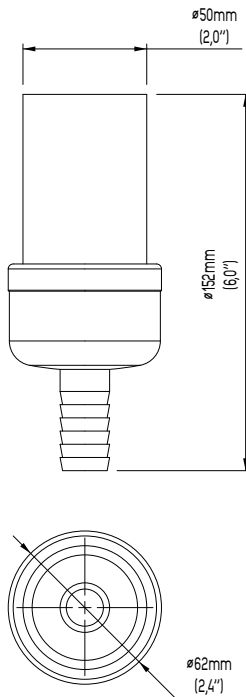



Arpool XS

GLARE CONTROL

Internal glare control:

Hex louvre

Provides low glare control with 45% less lumen output than product without louvres. Best for use when there is no need for segment beam cut off such as in half moon

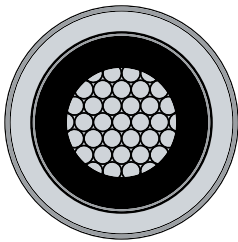

Half moon

Provides glare control by reducing lumen output and implementing a light beam cut-off, resulting in a 50% reduction in stray light and minimized light dispersion in undesirable directions.

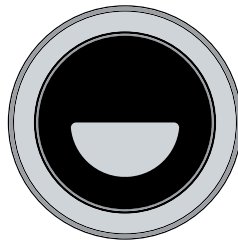



Arpool XS

MANDATORY ACCESSORIES

Technopolymer installation housing

Used to niche used to seamlessly integrate luminaire utilizing precision press fit with no exposed hardware.

Made out of technopolymer with single cable entry and suitable for marine and pool environments. Standard features include a 1.5m oil and water-resistant cable conduit, streamlining the installation process. Due to its size, the housing's back end intentionally lacks a sealed cable gland. Contractors are advised to review installation instructions for proper guidance.

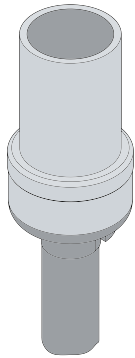

Power supply

A LED power supply, is an electrical device designed to control the power supplied to an LED or an array of LEDs. It plays a critical role in LED lighting systems as LEDs demand a specific type and level of electrical current or voltage for optimal operation. It's important to note whether a constant current or constant voltage LED power supply is required. The power supply should be installed in a dry and easily accessible area.

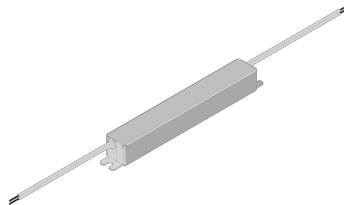



Arpool XS

OPTICS

Spot
Angle: 15°
Delivered lumen: 250lm

Flood
Angle: 40°
Delivered lumen: 150lm

Wide
Angle: 70°
Delivered lumen: 100lm

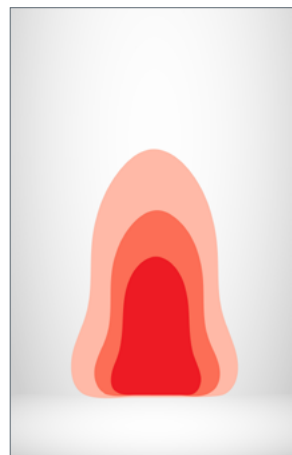
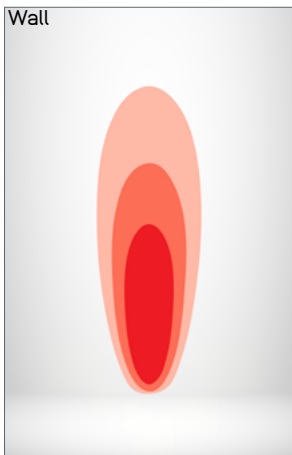
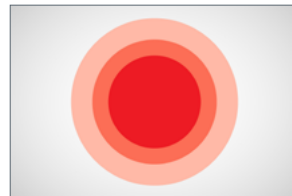
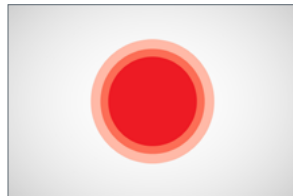
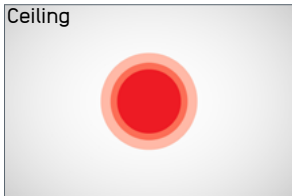

Spot + Hex
Angle: 15°
Delivered lumen: 140lm

Flood + Hex
Angle: 40°
Delivered lumen: 82,5lm

Wide + Hex
Angle: 70°
Delivered lumen: 55lm

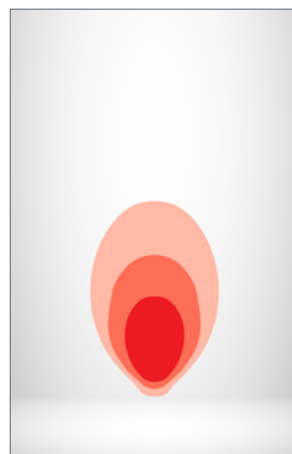
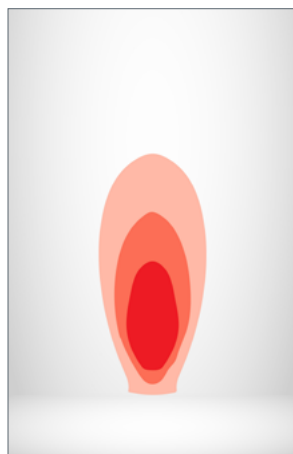
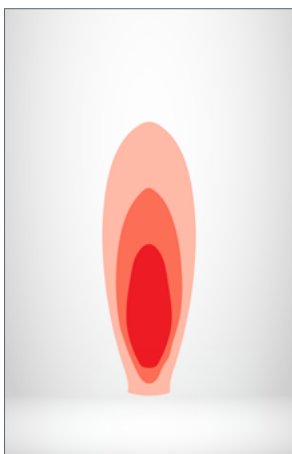
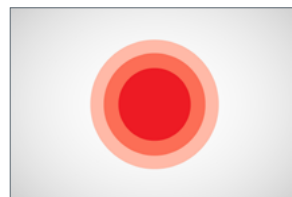
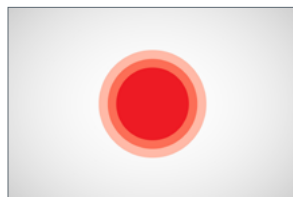
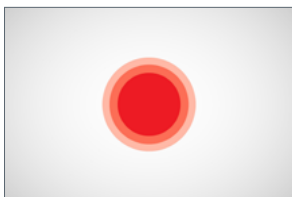

Notes

- Light output values based on 3W and 4000K product



Control

ON/OFF SYSTEM TOPOLOGY

Integrated systems:

- Heat Sense
- Flow Sense
- Split & Seal

System components

- Wiring and additional accessories leading up to the product feed cable are the responsibility of others.
- Housing and necessary accessories that are marked as mandatory must be ordered separately

System topology

- In the system design, any of the following system topologies can be utilized: line wiring, star wiring, or tree wiring.

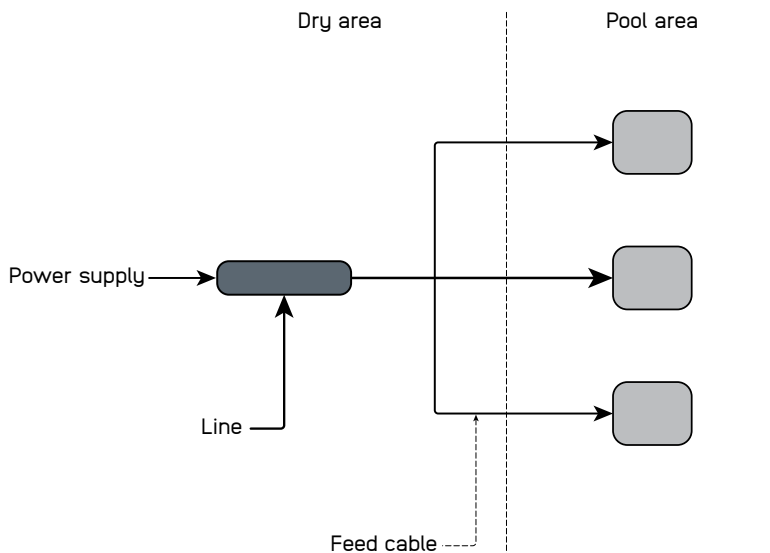

Addressing & dimming notes

- ON/OFF system does not allow device addressing
- Dimming of the product not available in this system

Segment length and limitations

- In a serial connection of multiple fittings, the maximum length of a cable loop is 50 meters, and the electrical circuit size is limited by power supply ratings, such as output voltage range.
- All wire splicing should be performed in a dry area to ensure a proper connection.
- Used in single colour applications

Fault tolerance

- In a serial connection, if one product fails, the rest of the system stops working.



Control

0-10V SYSTEM TOPOLOGY

Integrated systems:

- Heat Sense
- Flow Sense
- Split & Seal

System components

- The 0-10V system, wiring and additional accessories leading up to the product feed cable are the responsibility of others.
- Housing and necessary accessories that are marked as mandatory must be ordered separately

System topology

- In the system design, any of the following system topologies can be utilized: line wiring, star wiring, or tree wiring.

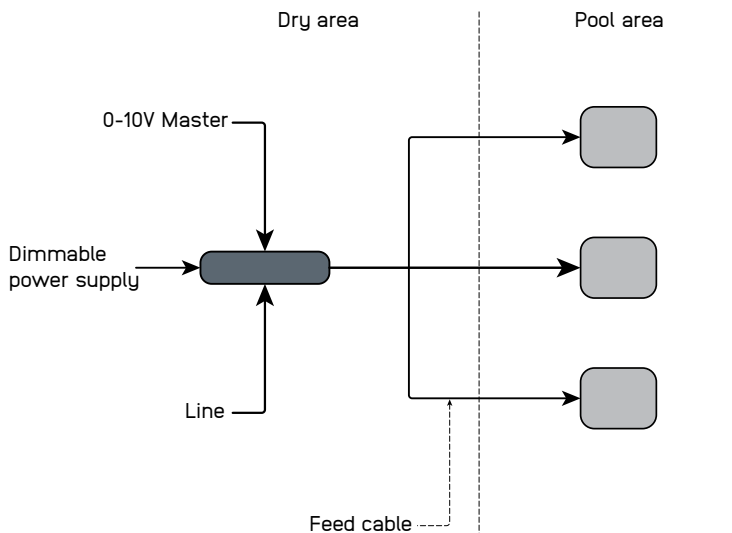

Addressing & dimming notes

- Without 0-10V dimmable power supply product can not be controlled
- Individual device addressing can be achieved by connecting each product to a separate output channel of the 0-10V dimmable power supply.
- Logarithmic and linear dimming options depend on the 0-10V dimmable LED power supply
- The dimming range is determined by the 0-10V dimmable LED power supply

Segment length and limitations

- The minimum controllable segment is one product.
- In a serial connection of multiple fittings, the maximum length of a cable loop is 50 meters, and the electrical circuit size is limited by power supply ratings, such as output voltage range.
- All wire splicing should be performed in a dry area to ensure a proper connection.
- Used in single colour applications

Fault tolerance

- If the LED driver is source type and in the case the control line doesn't have power the light fitting will turn at 100%. in the opposite case where the LED power supply is sink type, light will not work
- In a serial connection, if one product fails, the rest of the system stops working.



Control

DALI SYSTEM TOPOLOGY

Integrated systems:

- Heat Sense
- Flow Sense
- Split & Seal

System components

- The DALI system, wiring and additional accessories leading up to the product feed cable are the responsibility of others.
- Housing and necessary accessories that are marked as mandatory must to be ordered separately

System topology

- In the system design, any of the following system topologies can be utilized: line wiring, star wiring, or tree wiring.

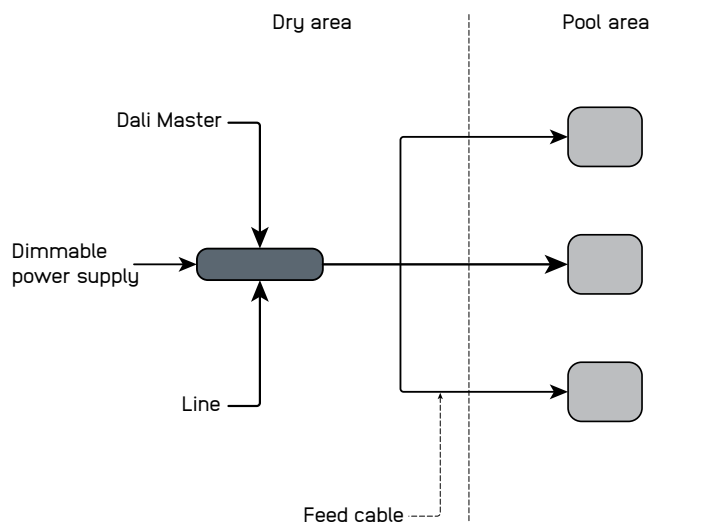

Addressing & dimming notes

- Without a DALI dimmable power supply, the product cannot be controlled.
- Individual device addressing (short address) and group addresses for up to 16 groups can be achieved by connecting each group of products to a separate output channel of the DALI dimmable power supply. A broadcast address targets everything on the line of the DALI dimmable LED driver.
- Logarithmic and linear dimming options depend on the DALI dimmable LED power supply.
- The dimming range is determined by the DALI dimmable LED power supply.

Segment length and limitations

- The minimum controllable segment is one product.
- A DALI dimmable power supply cannot control fittings individually unless they are connected to separate channels of a DALI dimmable power supply.
- In a serial connection of multiple fittings, the maximum length of a cable loop is 50 meters, and the electrical circuit size is limited by power supply ratings, such as output voltage range.
- All wire splicing should be performed in a dry area to ensure a proper connection.
- Suitable for both single-color and multi-color applications.

Fault tolerance

- In a serial connection, if one product fails, the rest of the system stops working.



Control

DMX SYSTEM TOPOLOGY

Integrated systems:

- Heat Sense
- Flow Sense
- Split & Seal

System components

- The DMX system, wiring and additional accessories leading up to the product feed cable are the responsibility of others.
- Housing and necessary accessories that are marked as mandatory must be ordered separately

System topology

- In the system design, any of the following system topologies can be utilized: line wiring, star wiring, or tree wiring.

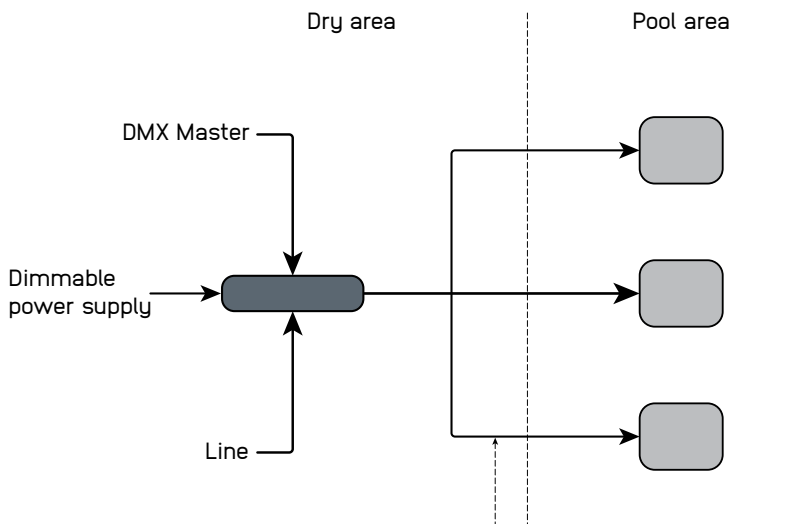

Addressing & dimming notes

- The minimum controllable segment is one product.
- A DMX dimmable power supply cannot control fittings individually unless they are connected to separate channels of a DMX dimmable power supply.
- In a parallel connection of multiple fittings, the maximum distance between the LED power supply and the last fitting in line is limited to the maximum allowed voltage drop.
- In a serial connection of multiple fittings, the maximum length of a cable loop is 50 meters, and the electrical circuit size is limited by power supply ratings, such as output voltage range.
- All wire splicing should be performed in a dry area to ensure a proper connection.

Segment length and limitations

- Without a DMX dimmable power supply, the product cannot be controlled.
- Individual device addressing (short address) and group addresses can be achieved by connecting each product or a group to a separate output channel of the DMX dimmable power supply.
- Logarithmic and linear dimming options depend on the DMX dimmable LED power supply.
- The dimming range is determined by the DMX dimmable LED power supply.
- Suitable for both single-color and multi-color applications.

Fault tolerance

- In a parallel connection, if one product fails, the rest of the system continues to operate.
- In a serial connection, if one product fails, the rest of the system stops working.