



MANUAL

AIRGLOW

WIRELESS MESH OUTDOOR LIGHTING CONTROL

AIRGLOW

wireless mesh outdoor lighting control

AirGlow combines advanced wireless outdoor lighting control with unique scalability and future IoT possibilities.

Using a standard Zhaga Book 18 connector and including major benefits such as LumenRadio's reliable wireless mesh technology, easy commissioning using Bluetooth and superior range through optimized radio performance, AirGlow offers a "connectivity-out-of-the-box" solution not seen before in the outdoor lighting control segment.

QUICK START GUIDE	3
Installing AirGlow	3
PRODUCT CHARACTERISTICS	4
MiraMesh explained	4
Bluetooth connectivity	6
Compliance	6
LIGHTING CONTROL	7
System, Zone, Scene and Group	7
Configuring AirGlow DALI and LSI port	9
Scene triggers	12
- Scene priorities	12
- Presence detection triggering	12
- Fade-/ Hold time	12
- Time triggering	13
- Astro Clock time triggering	13
- Manual triggering	13
- Example: Illumination of an intersection	15
- Example: Football stadium lighting	16
Failure modes	17
- Loss of communication	17
- Loss of communication during commissioning	17
- Loss of power	17
COMMISSIONING AND MAINTENANCE	18
Cloud service	18
Account types	18
Managing accounts	18
Giving user access	19
Security 20	20
Commissioning flow of Luminaries, Groups and Scenes	20
Replacing a malfunctional AirGlow	22
ELECTRICAL SPECIFICATIONS	23
Features	23
MEASUREMENTS	25
COMPLIANCE INFORMATION	25
NOTIFICATIONS	25

QUICK START GUIDE

Installing AirGlow

Make sure you have internet connection during your commissioning of AirGlow and that your Bluetooth is turned on.

Wireless range

Up to 1500m line of sight between two AirGlow's

Bluetooth range

Max 25m pole height
Max 25m from pole

1. Download the AirGlow app in AppStore or Google Play. Scan the QR code.



2. Install the first AirGlow in a centrally located luminaire.



3. Twist and lock AirGlow into place.

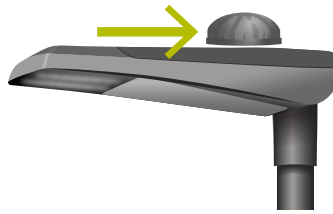

4. Discover the AirGlow units using the app and start the commissioning process.



5. Select the required number of DALI channels under DALI port, 1, 2, 4 or 6 channel. If required configure luminaire colors using the "Configure light channels" feature.

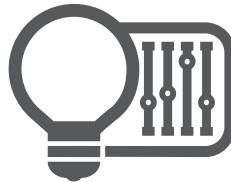

6. At the commissioning stage remember to create/add AirGlow in a group.

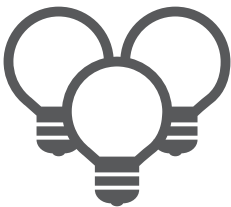

7. Commission the AirGlow by clicking Apply.



8. Repeat, from step 4, for all AirGlow's.



9. When all AirGlow's have been configured you can start creating the scenes.

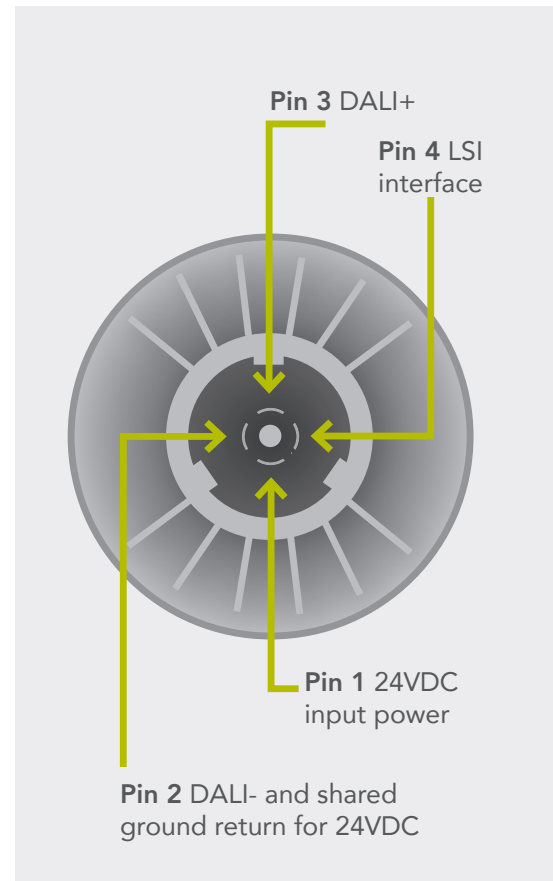

PRODUCT CHARACTERISTICS

MiraMesh explained

AirGlow wireless connectivity for lighting control is based on LumenRadio's MiraMesh technology which enables a large-scale and easy-to-install self-healing wireless mesh network. By using state of the art algorithms for meshing, over the air firmware updates, commissioning and reliability, unparalleled performance is achieved.

As every AirGlow automatically repeats the communication, range is extended well beyond the maximum range for any single AirGlow. Therefore large geographical areas can easily be covered. Thanks to the MiraMesh connectivity, free line-of-sight range between AirGlow's in clear conditions has been tested up to 1500m without latency and 100% communication success.

MiraMesh provides a highly synchronize clock within the meshed network characterized in rapid response and synchronized triggering of scenes. The time synchronization master is by default the first unit being commissioned and it is recommended to start commissioning of a central positioned AirGlow for best performance.

For wireless communication systems it is recommended to plan for a maximum range between two units in a meshing system to be 1/10 of maximum range. I.e. for the AirGlow a maximum range of 150m is recommended which is far better than any competing system. Typical maximum free line of sight range in clear conditions for other competing systems is 100m meaning that range between two units should not exceed 10m. This inferior range will limit such technologies use cases for outdoor lighting control.

In this chapter:

- MiraMesh explained
- Bluetooth connectivity
- Based on Zhaga book 18 hardware

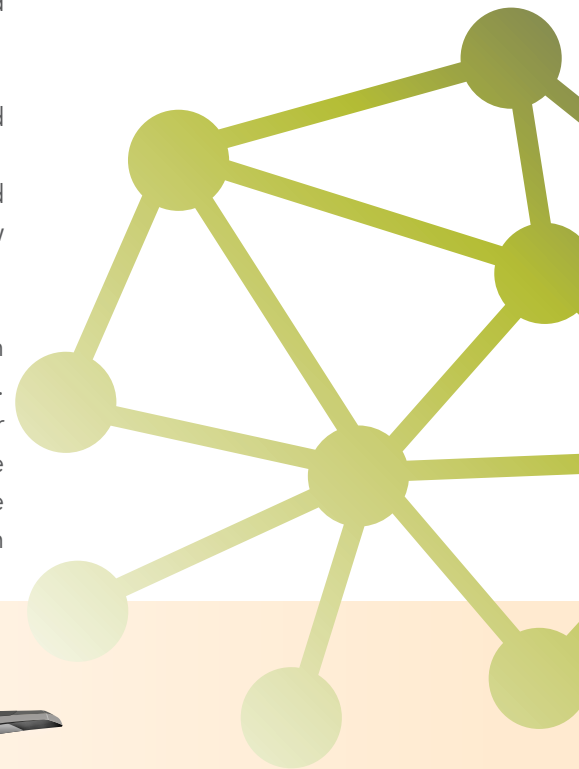

300m wireless range required in case of malfunctioning luminaire/ AirGlow



The 1/10 -recommendation is based on the physical facts that wireless communication systems range will be reduced by, for example, surrounding buildings, blocking solid objects, snow or heavy rain. Planning for a maximum distance of 150m range between two AirGlow will give a good margin for non optimal conditions but will also prevent so called islanding from happening. This recommended distance is superior to many competing systems typically having 100-150m free line of sight distance which will be reduced to 10-15m in non optimal situations.

Islanding is a phenomena that happens when the line of communication is broken leaving two islands of luminaires with no communication. Islanding can happen when operating at the very limit of the maximum possible range in a meshing system. Street and road lighting is commonly installed as a string of pearls and the meshing communication follows this path. During these circumstances a malfunctioning unit would break the communication path as the distance between the neighboring units would be beyond maximum distance. This means that lighting control data communication between those two islands would not be possible.

It is therefore recommended not to exceed 150m free line-of-sight between two single AirGlow in a system. This will give a sufficient margin even in non-optimal wireless conditions or in case of a luminaire and/or an AirGlow malfunctions as the signal would have to travel twice the distance.

MiraMesh has an unparalleled wireless communication reliability thanks to the patented Cognitive Coexistence technology. Utilizing MiraMesh in AirGlow results in the most resilient wireless lighting control system on the market.

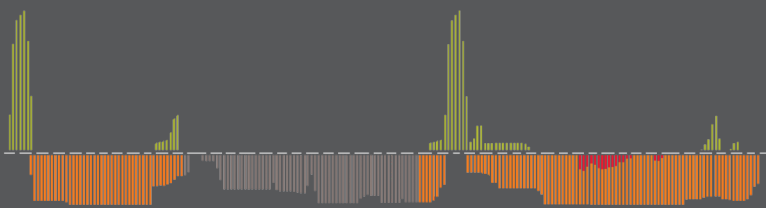
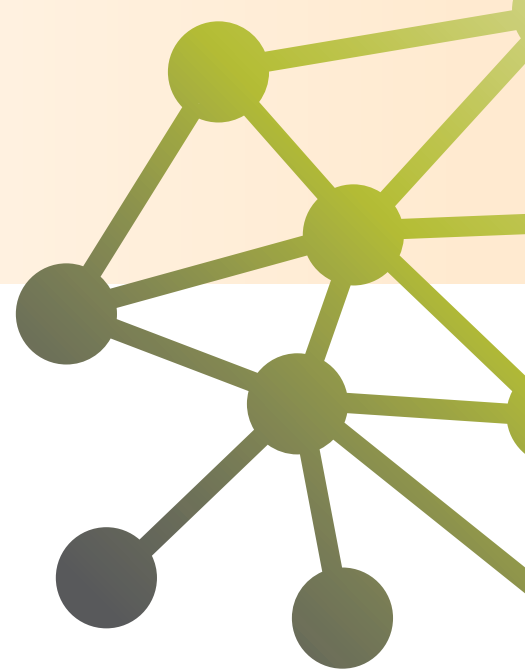

Cognitive Coexistence will automatically adapt and select the best available frequency for communication avoiding other communication systems or deliberate interference.

Cognitive Coexistence, together with the self-optimizing meshing technology in MiraMesh, has been used and proven successful for wireless control applications within lighting, industrial automation and building automation.

Bluetooth connectivity

The AirGlow is Bluetooth compatible and thanks to an advanced antenna technology design inside the AirGlow, the Bluetooth maximum communication range has been extended beyond what is normally seen from Bluetooth technology enabled devices.

A minimum range of 25m from an AirGlow mounted on a 25m light pole has been successfully tested, although a longer range is possible during good conditions. At a pole height above 20m, optimal performance is achieved at a distance at least 3m away from the light pole.

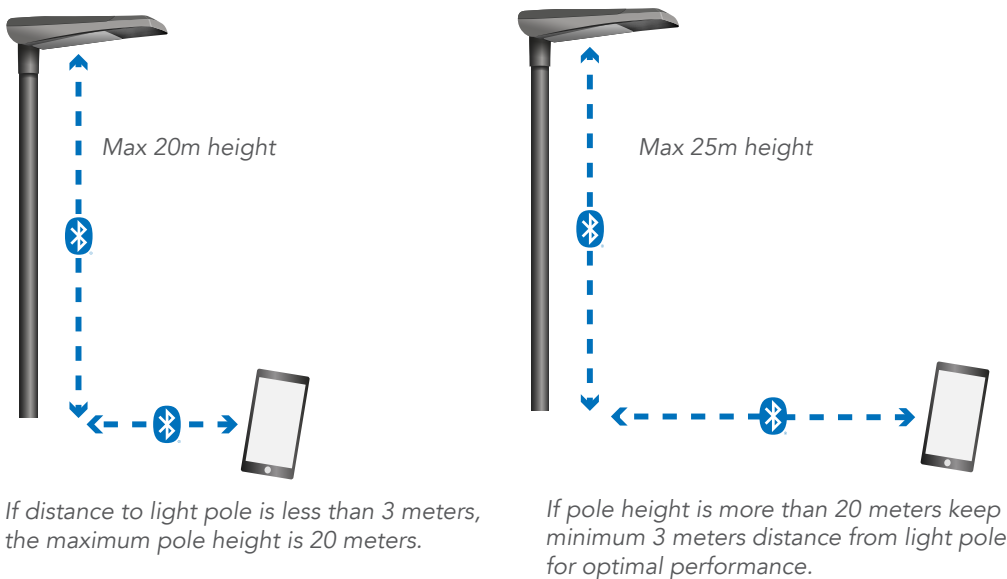

CLICK OR SCAN
TO BE REDIRECTED



Thanks to the AirGlow being Bluetooth enabled all commissioning and maintenance can be done with a smartphone and the AirGlow app. The AirGlow app is available for download through App Store for Apple iOS devices or Google Play for Android devices.

Compliance

The AirGlow Outdoor is Zhaga book 18 hardware compliant and is designed for outdoor lighting control, ideally for Group control of luminaires but individual control is also possible. The AirGlow also has support for lighting control of Scenes through the General Digital I/O/LSI pin which can be used to trigger a Scene on high level input.

AirGlow must be powered by a 24V DC power supply and an external DALI power supply of at least 60mA.

AirGlow is D4i certified (device type D) and DALI2 certified.

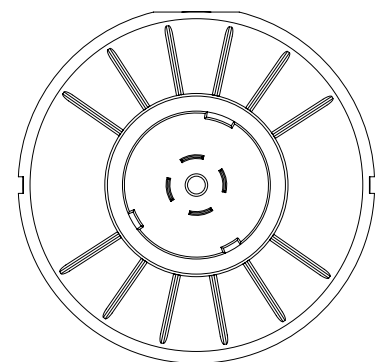

LIGHTING CONTROL

System, Zone, Scene and Group

An AirGlow system consists of a number of entities required to be configured for proper operation. The first entity required to be configured in an AirGlow system is called a "System", which is typically a larger area such as a city district (outdoors) or a building (indoors).

The next entity is called a "Zone" (a System consists of one or more Zones). A Zone is typically the size of a city block (outdoors), floor or a part of the floor (indoors). Within the Zone entity all lighting control scenarios are configured and performed.

AirGlow offers real-time performance within the Zone and is designed for sub-second response time and sub second synchronization of a Scene across the Zone, which will prevent what is called the "popcorn effect" between luminaires. In a future software update, possibility for a Zone to trigger another Zone will be added as well as remote triggering of Zones from a CMS (Central Management System).

In this chapter:

- System, Zone, Scene and Group
- Configuring AirGlow DALI and LSI port
- Scene triggers
- Luminaires, Groups and Scenes configuration
- Failure modes

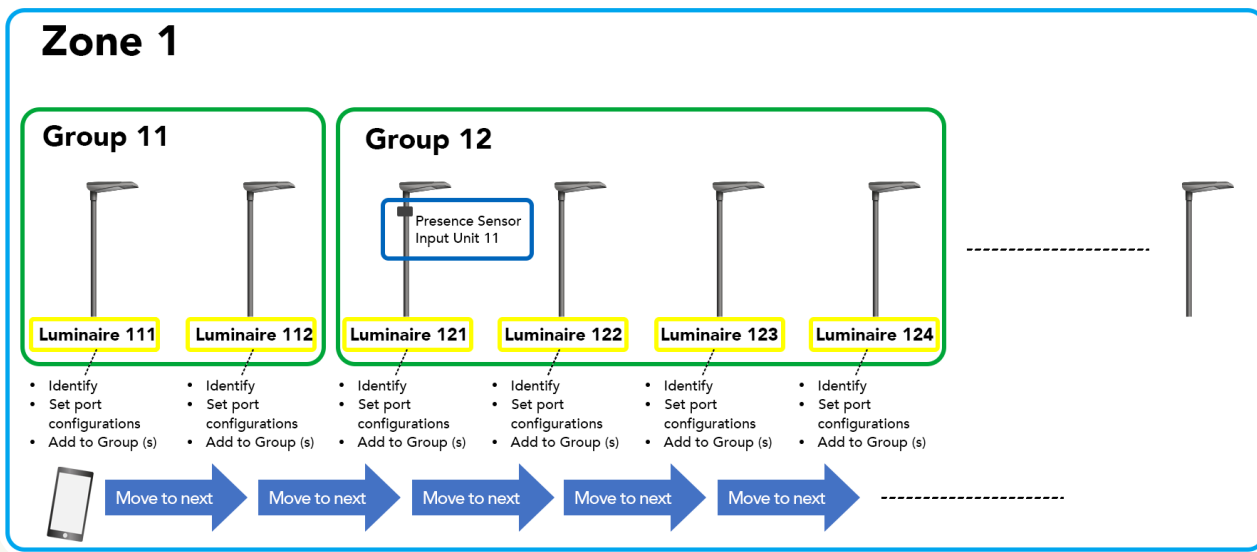

Above is an example of a System having four Zones and each Zone having four Groups of luminaires. Within each Zone, Groups of luminaires are added and a Scene can be set to affect one or multiple Groups. At Zone level so called "Input Units" are added which are used to trigger a Scene. Input Units can be a set time trigger or presence triggering. As the Input Units are added in the Zone advanced lighting control scenarios can be created as it is possible to have one Input Unit to trigger one or multiple Scenes for multiple Groups.

Also, a luminaire can be added to multiple Groups thereby providing full flexibility. It is recommended to only add luminaires with the same color mixing capabilities in the same Group. For instance luminaires with RGBW capabilities should not be mixed with WW/CW luminaires.

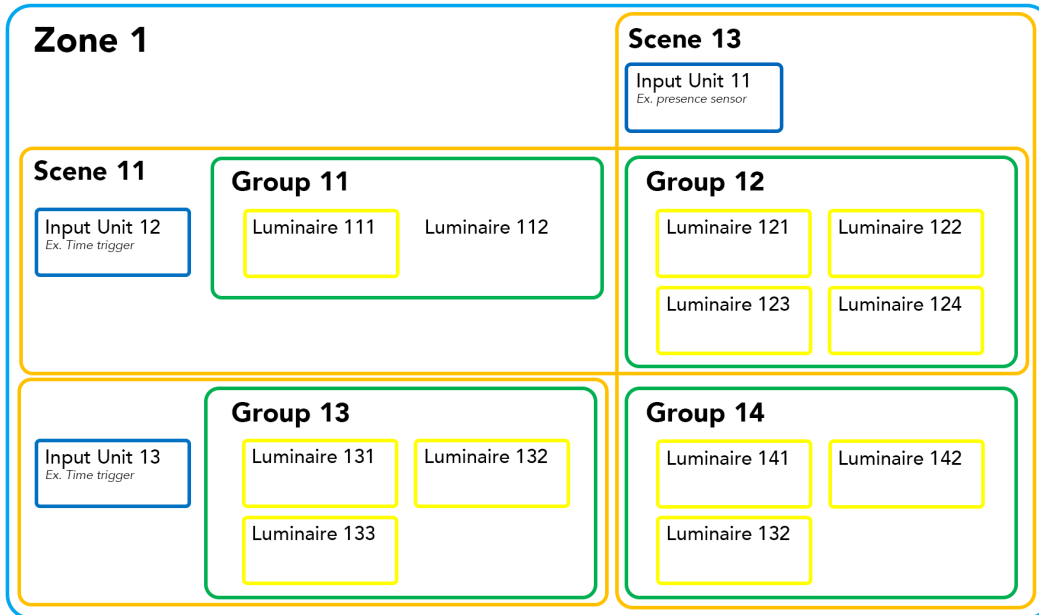

The illustration above is an example of an advanced configuration in a Zone. In the picture above, four Groups of luminaires have been created (note that Luminaire 132 is found in both Group 14 and Group 13). Three Input Units are added to the Zone where each is set to trigger a Scene.

Group 11 and 12 are added to Scene 11 but Group 12 is also added to Scene 13 which also has Group 14 added. Group 13 is only added to Scene 12

This results in Group 12 will have two Scenes where one Scene will be triggered by the Input Unit 12 (time trigger) and one by Input Unit 11 (presence sensor).

Furthermore, Luminaire 132 added to both Group 13 and 14 will respond to Scene 13 and Scene 12. When a Group of luminaires are added to different Scenes which might become active at the same time AirGlow has a set of priorities for which Scene should take precedence over the other, see chapter "Scene Triggers" for further details.

Configuring AirGlow DALI and LSI port

AirGlow comes with two interfaces for lighting control, DALI and LSI for sensor input. AirGlow comes default configured for DALI broadcast communication and LSI input disabled.

DALI broadcast effectively means that any LED driver on the DALI bus will respond to dimming commands. If the Luminaire is a intensity dimming only type no further DALI configuration for AirGlow is required. For all other types of luminaires that are tunable white (Warm White / Cool White) and/or RGBW AirGlow needs to be configured in app for proper DALI operation.

If a presence sensor or a push button is to be used together with an AirGlow the LSI port needs to be enabled in app.

The configuration is applied to the AirGlow when the apply button is pressed in app. If the AirGlow previously not has been configured the AirGlow will also receive all network credentials and security parameters to join the lighting control network. This is an automatic process and no settings by the user are needed.

AirGlow utilizes DALI Direct Arc Power Commands (DAPC) to control the dimming level of the driver. A transition between two different dim levels is done by sending the new DAPC level and a fade time. This will result in a smooth dimming to a new level.

AirGlow is factory configured for linear dimming. For perceived linear dimming by the human eye the driver should be set to logarithmic dimming. If the driver is set to linear dimming the it will still be fully operational.

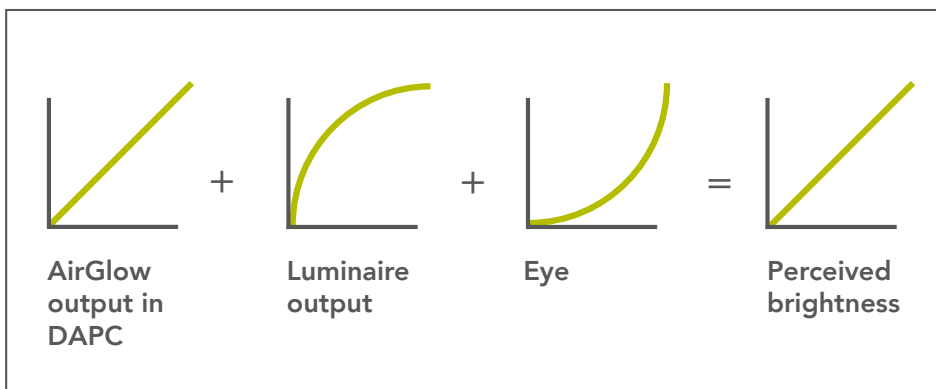
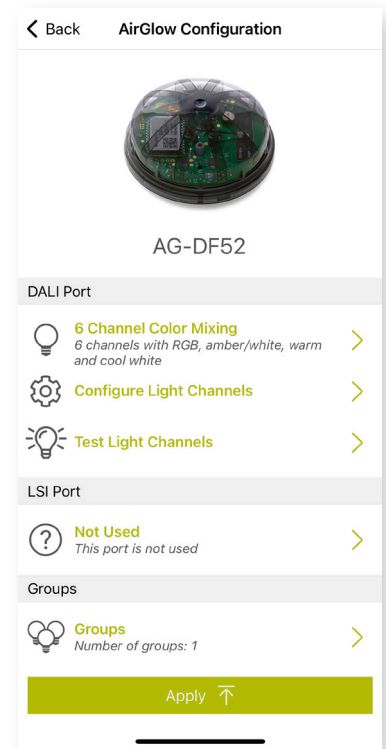

DALI configuration

The DALI port can be set from 1 up to 6 channels DALI DT6 control for tunable white (Warm White / Cool White) and/or RGBW. The possible combinations can be found in the table below.

DALI Channels	Combination
1	Intensity only
2	Cold White (CW), Warm White (WW)
4	RGB (Red, Green Blue), Amber/White (A)
6	Cold White (CW), Warm White (WW), RGB (Red, Green Blue), Amber/White (A)

These channels are controlled with DALI group addresses, which allow multiple drivers/ luminaires to be controlled through a single AirGlow unit.

For a tunable white and/or RGBW luminaire the LED drivers can either be configured through the AirGlow app or be preconfigured before install using a DALI commissioning tool.

The AirGlow app provides a powerful feature for configuring each color channel (tunable white and/or RGBW). The color channel configuration can be done even after the luminaire has been installed. If not using the AirGlow app please refer to table below for required DALI configuration for the drivers.

Color Channel	Default DALI group address
Cold White (CW) or Intensity (for 1ch)	0
Warm White (WW)	1
Red (R)	2
Green (G)	3
Blue (B)	4
Amber (A)	5

Required configuration if using a 3'rd part DALI commissioning tool

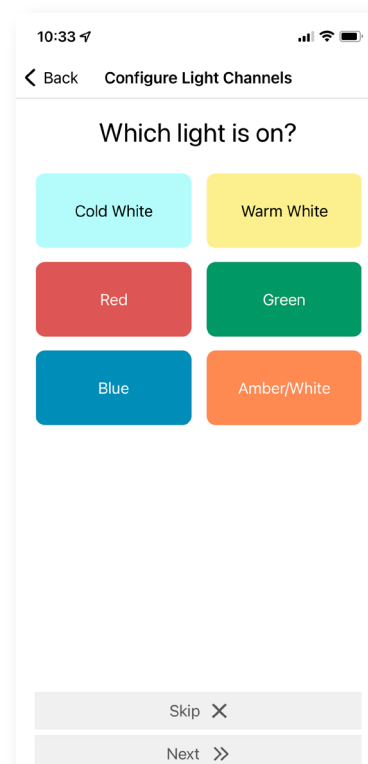

LSI port

A 24VDC signal can be applied to the LSI port to trigger Presence Scenes. A typical user case is having a presence sensor triggering the LSI pin but for instance a rocker switch could be used for manual triggering by the user. Please note that the LSI port needs to be activated in the "AirGlow Configuration" view in the app before use.

An AirGlow unit can either have both the LSI and DALI ports configured at the same time or only one of the two ports. This allows an AirGlow unit to interface a presence sensor without requiring anything connected to the DALI bus. The benefit of such configuration could for example be a presence sensor to be placed in an optimum position for triggering of Scenes.

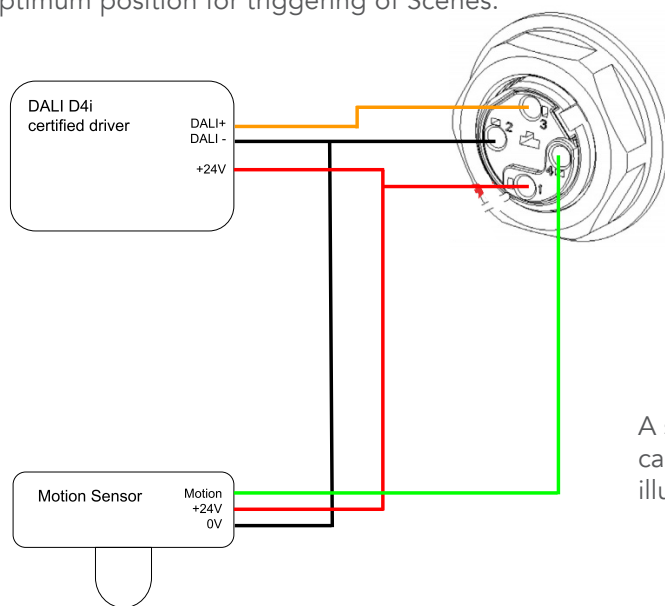

A sensor with a dry contact output can be used to trigger the LSI pin as illustrated in the picture.



Scene triggers

A Scene can be triggered by either an input signal on the LSI pin of an AirGlow (typically a presence sensor) or it could be triggered by a specific time on a specific day of the week. These triggers are called Input Units in the app and are always added to the Zone. This allows an Input Unit to trigger a Scene that includes an individual Group or multiple Groups.

- Scene priorities



It is fully possible to have multiple Scenes activated at the same time, thereby allowing for advanced lighting controls scenarios. If two or more Scenes are activated at the same time, AirGlow will enable one Scene in the following order of priority:

1. A presence Input Unit triggering a Scene takes precedence over any kind of time trigger (set absolute time or astronomical)
2. Set absolute time takes precedence over astronomical time triggered scene.
3. Astronomical time triggered scene has the lowest priority.

On equal priority, the last triggered Scene takes precedence.

- Presence detection triggering



A presence detection Scene trigger has the highest priority by default in the app. This means that if a time triggered Scene is activated for a Group a presence triggered Scene will take precedence if triggered and become active for the Group.

At "Absence" the previously triggered Scene will become active again. "Absence" is defined as no presence detected during the set hold time and the set switch off notice time. If presence is detected during the hold time and switch off notice time, restart from set hold time will be done.

The trigger signal is distributed wirelessly throughout the Zone with high precision resulting in sub-second response time for the Groups included in the Scene.

If it is needed to prevent presence-triggered Scenes becoming active during times of the day when no light output should be allowed (e.g. during daytime for outdoor lighting), time limits for presence-triggering can be set in the AirGlow app.

-Fade-/ Hold time

It is possible to set fade times in the app for activation (fade in) and deactivation (fade out) for a Scene. For presence triggered Scenes it is also possible to set a hold time, which is the time a Scene should be active upon absence until the Scene is faded out.



- Time triggering

Time triggering will be synchronized among all AirGlow and a time triggered Scene will be triggered in the Zone with the same high precision as for presence triggering (i.e. sub second response). Time triggering has lower priority by default than presence triggering and therefore presence triggering takes precedence over time triggering if two such Scenes are activated at the same time.

A Scene can be set to be triggered at a specific time during any or all of the weekdays providing full flexibility if for example different scenarios and timings are required during weekdays and weekends.

In order to have a synchronized scene activation for all luminaires a 30s delay is added by AirGlow to the set time.

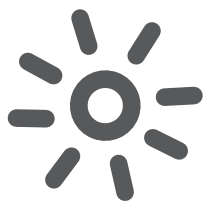

- Astro Clock time triggering

A special case of time triggering is Astro Clock triggering which allows a Scene to be triggered or de-triggered at sunset and/or sunrise. If a Astro Clock time triggering is combined with set Time Triggering unexpected behavior might occur as set Time Triggering has higher priority than Astro Clock time triggering. This can typically happen during summertime as a set Time Triggered scene may be activated after sunrise if Astro Clock deactivation happens before set Time Triggering activates.

Astro Clock times are automatically set up during commissioning for a full year and do not require any further adjustments as every AirGlow contains a high precision time circuit. The Astro Clock time triggering will also account for Daylight Saving Time (DST).

Astro Clock is made possible through the AirGlow app which gets the geographical position through the phone's GNSS receiver (GPS). The position is used by the app to get the times for sunset and sunrise for each day throughout a full year. This information is stored in every AirGlow preventing a single point of system failures.

Note that for proper operation of Astro Clock time triggering the app needs to get access to the phones location service. This needs to be manually accepted by the user when prompted by the phone.

- Manual triggering

It is possible to configure each AirGlow for manual light control by applying 24VDC to the LSI port through, for instance, a dry contact connected between the AirGlow power input pin and LSI pin. The Scene that shall be triggered is set up in the app as a presence Scene and the manually triggered AirGlow LSI input is added as an input unit. As long as the voltage is kept high the presence Scene will be active. This allows for Scenes triggered by an end user (for example manual control for illumination of a sports arena). Multiple AirGlow units can be used for controlling multiple Scenes which will appear as input units during the presence Scene setup.

Luminaires, Groups and Scenes configuration

It is recommended to only add luminaires with the same number of DALI DT6 channels. For example a Group should not include a luminaire with warm white/ cold white (WW/CW) capabilities and a luminaire with RGB/WW/CW capabilities. Although fully possible to mix luminaires with different numbers of DALI DT6 channels the risk is that unexpected behaviours during Scene setup will occur.

If Groups with different light output capabilities are added to a Scene, every Group light output will have to be set individually. This is done in the AirGlow app in the "Scene Visuals View". In the example below two Groups have been added to a Scene. Group 0 contains 2ch CW/WW luminaires and Group 1 contains 1ch luminaires.

A luminaire can be a member of up to 16 Groups and a Group can be added in up to 8 Scenes giving full flexibility for advanced scenarios to be created.

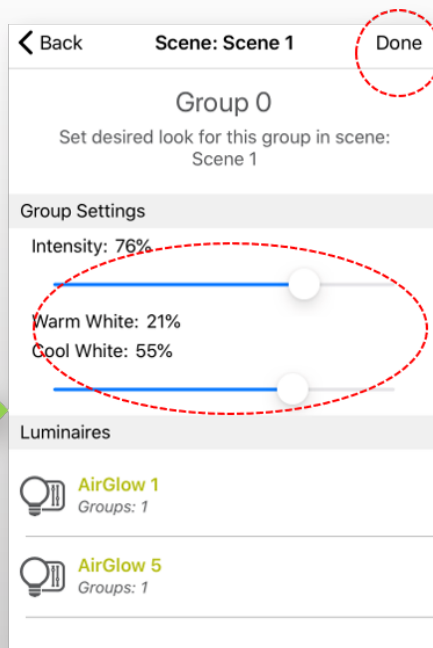
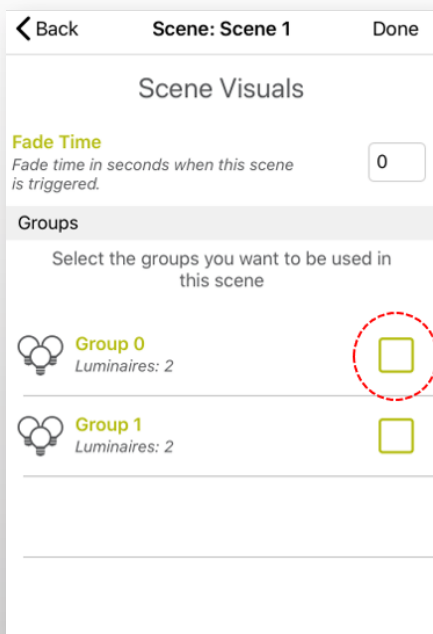

Start by pressing Group 0 to navigate into the Group Settings view.

In the group Settings view the output can be adjusted for the group through the sliders until the requested light output is reached.

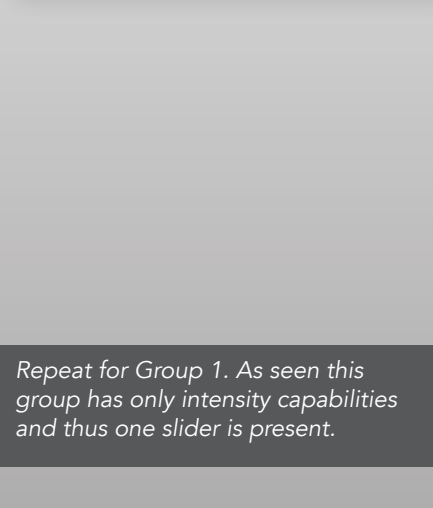

Repeat for Group 1. As seen this group has only intensity capabilities and thus one slider is present.

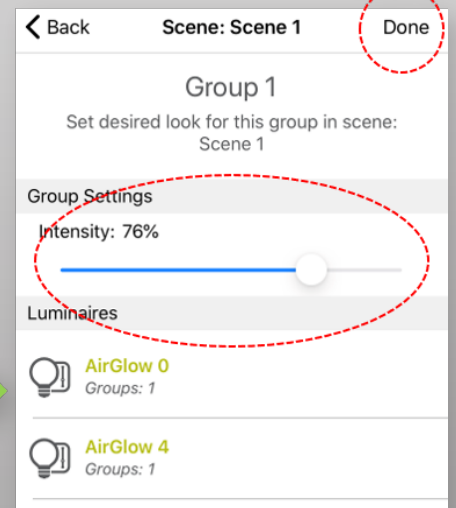
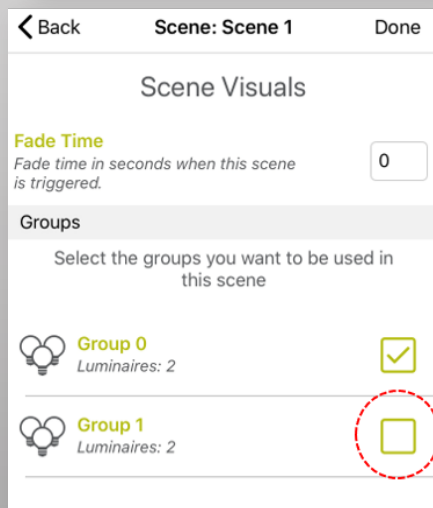

- Example: Illumination of an intersection

An example of an advanced setup could be an intersection where a luminaire is added to two different Groups as illustrated and described below.

In the middle of the intersection a luminaire has been added to Group 1 (red) and Group 2 (green), this luminaire is named Luminare 12.

All luminaires in Group 1 and 2 have WW/CW capabilities. Group 1 and 2 are added to an event of time triggered Scenes as follows:

- An Astro Clock time triggered Scene, Scene T1, is activated at sunset and deactivated at Sunrise. From midnight to 5 AM a set Time Triggerd Scene T2 is active with reduced lumen output.
- Group 1 is also added to Scene P1, which is triggered by presence sensor 1. Group 2 is added to Scene P2, which is triggered by presence sensor 2. Both presence triggered Scenes are set only to be allowed to be active from midnight to 5 AM.
- Because presence triggered Scenes have higher priority than the time triggered Scenes the luminaire added to both Group 1 and 2 will activate Scene P1 or Scene P2 if either of the presence sensors detects presence. Luminare 12 belonging to both Group 1 and 2 will therefore activate either Scene P1 or P2 if presence sensor 1 or 2 triggers.

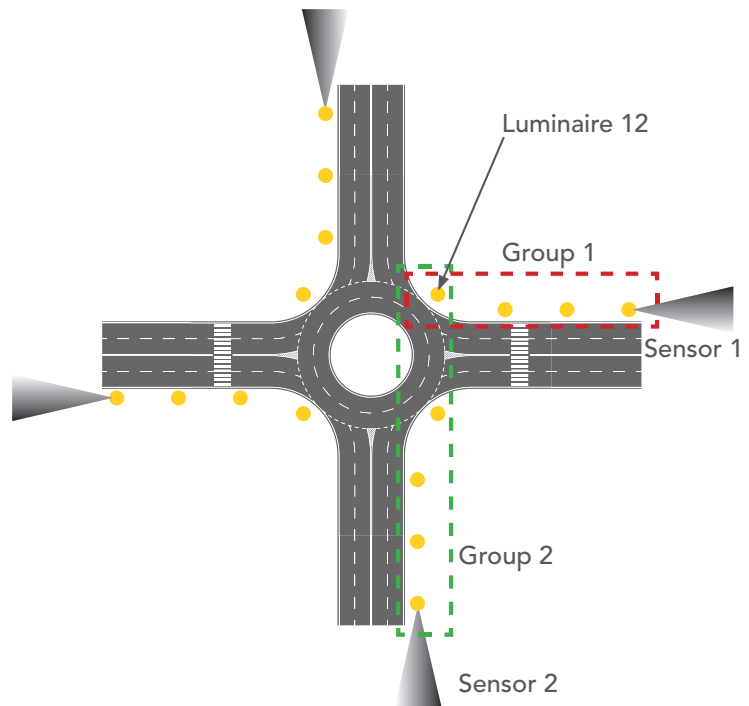

The resulting light scheme for Luminare 12 is illustrated below.

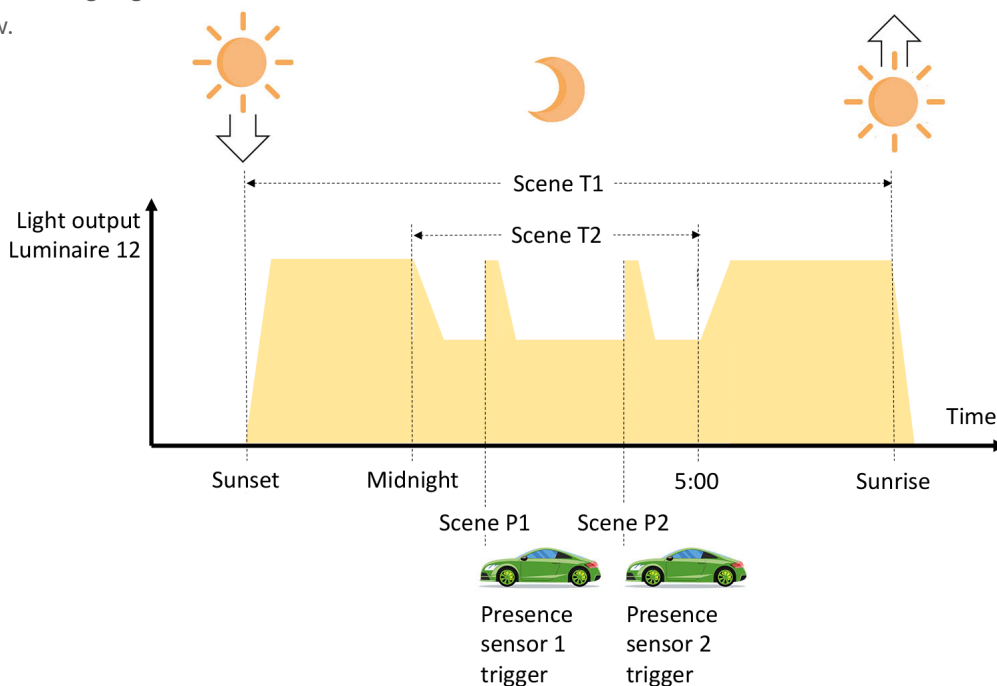

- Example: Football stadium lighting

For a football stadium typically full light level is required on a match day but for training days light levels can be reduced.



This can be done by setting up two AirGlow for manual control through LSI input triggering of Scenes. This is made possible because AirGlow input units (triggers) are added to the Zone level and can be set to trigger Scenes in one or many Groups. In this example a dry contact is connected between the 24VDC power supply input pin and the LSI port on each AirGlow. AirGlow 1 is set to trigger a presence Scene named Scene 1 made for match day and AirGlow 2 is set to trigger presence Scene 2 made for training.

As long as the LSI pin has a 24VDC level the Scene will be active. All luminaires are of the same type and have the same capabilities and added to the same Group. The resulting lighting scheme can be seen in the illustration below.

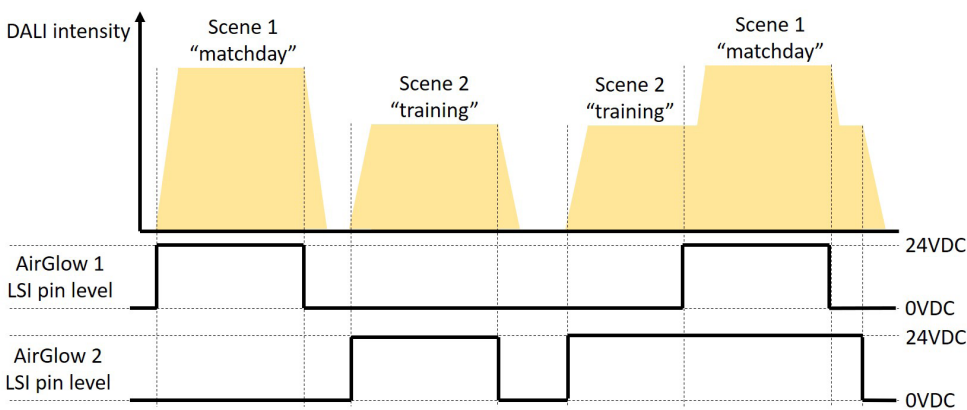

As seen above if Scene 2 and Scene 1 is activated during the same time Scene 1 takes precedence over Scene 2. This is because of the Scene prioritization feature in AirGlow as previously mentioned. In the example above AirGlow will prioritize Scene 1 "matchday" when both Scenes are set active as Scene 1 is the last triggered.

1. A presence input unit triggering a Scene takes precedence over a time input unit triggering
2. On equal priority, the last triggered Scene takes precedence.

Failure modes

- Loss of communication

AirGlow wireless communication is built on the ultra reliable and patented MiraMesh from LumenRadio. As previously mentioned, MiraMesh will automatically build a self-healing mesh network and the MiraMesh algorithms used for communication and range will provide the most robust solution on the market.



If, however, a malfunction should occur resulting in loss of communication, the affected AirGlow will activate the Scene with highest priority.

AirGlow(s) with loss of network communication will in case of:

1. No Scenes have been set up all DALI Groups will be set to 50% light level. This typically happens before an AirGlow has been commissioned and meshed communication been setup.
2. Only presence Scenes and no time triggered Scenes have been set up all DALI Groups will be set to 50% light level.
3. Time triggered Scene(s) have been setup those Scenes will still be triggered and the AirGlow will operate in stand alone mode.

- Loss of communication during commissioning

If the Bluetooth link between the phone and an AirGlow is interrupted during commissioning the configuration is reset to the same setting as the latest commissioning data. If no commissioning has previously been done, the AirGlow unit will be reseted to factory settings. Once the Bluetooth link has been established commissioning can be restarted once again.

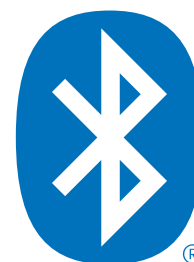

If the Bluetooth link is interrupted due to the phone being out of Bluetooth range, try to move closer to the luminaire before restarting commissioning. Bluetooth technology which is used between phone and AirGlow units has an inferior range compared to the MiraMesh technology used for lighting control communication between AirGlow units.

- Loss of power

AirGlow is designed for being possible to operate in systems where the power grid is either intentionally or unintentionally interrupted. All configuration is safely stored in a non-volatile memory and configuration data is retained even in a powerless state.



The high precision clock in AirGlow that is used for time triggered Scenes and Astro Clock triggering has a built-in battery backup. Once an AirGlow is commissioned the clock will be operational even though left in a powerless state for up to 180 days. Once powered there is no need for recommissioning any AirGlow to set the clock. In extreme conditions with an ambient temperature reaching 50 degrees Celsius the time in a powerless state will be reduced to 120 days. The AirGlow battery backup will automatically charge to nominal capacity while powered.

COMMISSIONING AND MAINTENANCE

Cloud service

All commissioning data from an AirGlow setup is safely stored in a secure cloud service which means that the commissioning data can be accessed off site. All data stored is regulated by GDPR for personal integrity.

Assigning access is easily done in the smartphone app, please refer to the "Managing Accounts" section for further details.

Account types

System Owner - Any user creating a system will by default become the System Owner who can grant or revoke access for an installer. A system owner can also transfer system ownership to another System Owner

Installer - gets access by the System Owner. An Installer can commission AirGlow units and also add (grant access) new installers. An installer cannot revoke access to a system for another installer.

Managing accounts

To become an Owner or Installer of a System you need to first create an account. This is the first page you will see when opening the AirGlow app. If you already have an account just sign in with your credentials. Otherwise click "Create Account".

You need to fill all required fields on the "Create Account" page. When done, click the "Create Account" button.

In this chapter:

- Cloud service
- Account types
- Managing accounts
- Giving User Access
- Change Owner remove User
- Security
- On-site installation
- Commissioning flow of luminaries, Groups and Scenes
- Replacement of malfunctioning AirGlow

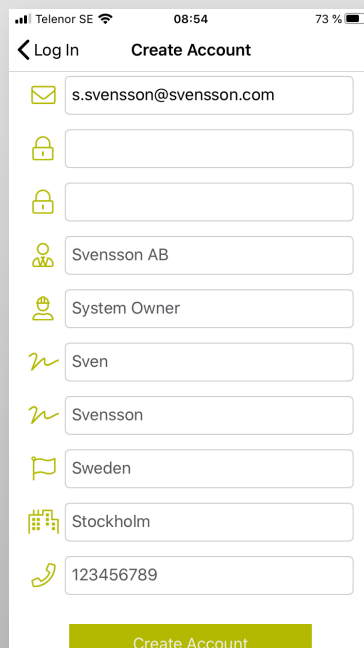
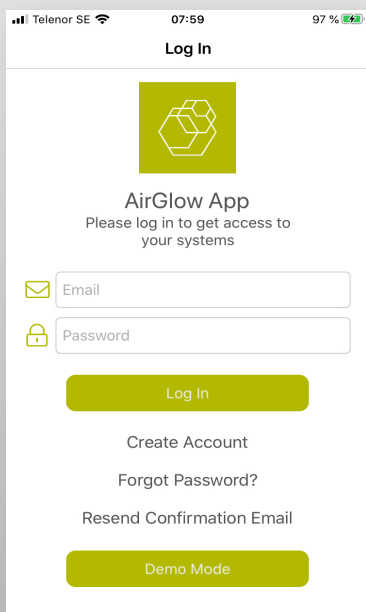

Giving user access

As a System Owner you can give access to other users, installers, maintenance personnel and change Owner.

Click on the wheel in the top right corner in your System. In System Settings you see what System you are in and at the top you have "User Access", click it.

In the "User Access" page you will see who is already the Owner and if there are any other Installers with access. Click the "Add Installer" button and fill in the email address of the person you wish to give access to. This person then needs to create an account before getting access to the System. When the account is created they will get access to the System.

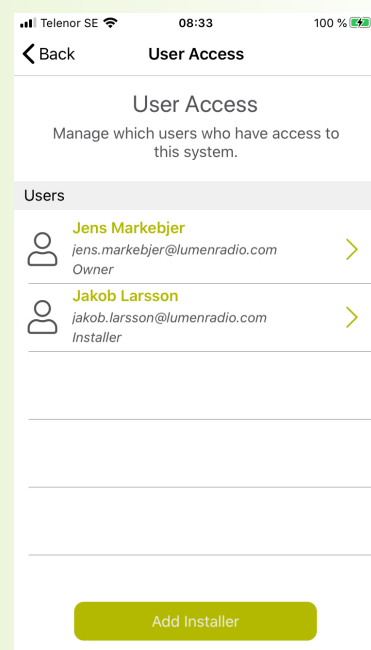
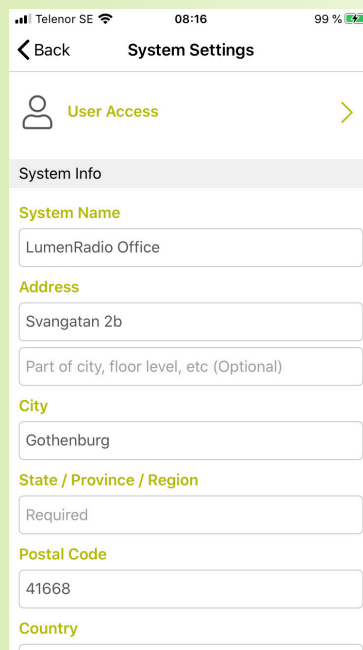
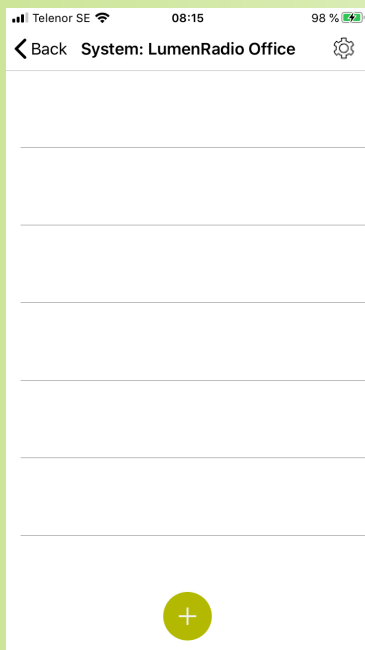

Security

All communication over Mira and Bluetooth is encrypted by AES-128. There is also protections against MITM and replay attacks.

Commissioning flow of Luminaires, Groups and Scenes

When commissioning your AirGlow's we recommend that you start with a centrally located luminaire.

1. Start by creating a System if previously not have been setup.
2. Create Zone.
3. Add your AirGlow's as follows.

Start by Identifying and set port configuration for every AirGlow in the Zone and then add to Group(s).

During this configuration, all networks security parameters are set up as an automated background process without need for user interaction. Network security knowledge from the installer is not required.

The configuration is done via the app through Bluetooth and therefore the smart device used for setup needs to be within Bluetooth range.

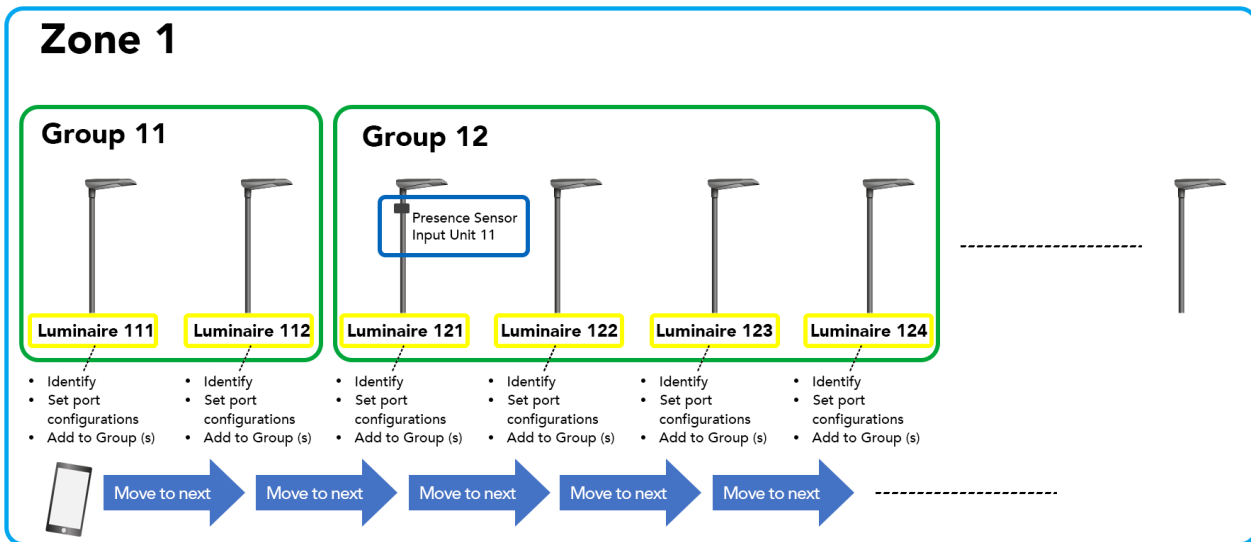

When the AirGlow in the Zone has been configured the MiraMesh network is automatically setup, allow up to 10 minutes for the network to configure. After the network has finished setup all scene triggers and scene visuals can be programmed and commissioned from any point in the network through the AirGlow app.

To set your Trigger/-s, dim level, color temperature and RGB click on the Scene button in the bottom menu. You need to add the Scene by clicking the +. Choose between Time Triggered Scene and Presence Triggered Scene, name it. Choose the Input Unit that will control this Group, then click Next. Choose days and time if you wish to have those specifically. All day = 00:00-23:59.

Scene Visuals is where to set the Fade In, Hold, Fade Out time and what groups to add. Click on the desired group-/s and make the settings. The luminaires involved are seen in the bottom of the page. Set Intensity and/or Color Temperature by using the sliders. Set the color with the color wheel. Click Done twice. Finished.

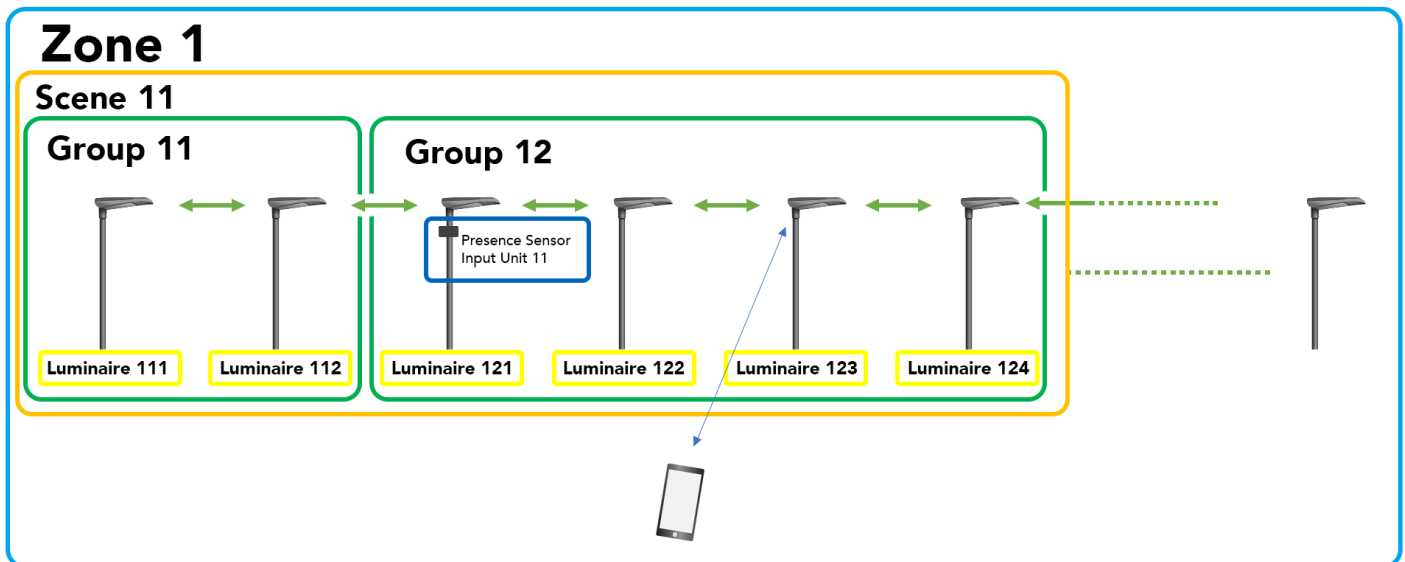

Replacing a malfunctioning AirGlow

1. Locate the malfunctioning AirGlow and replace it with a functional AirGlow. In the app navigate to the malfunctioning AirGlow and tap on it. In the menu choose "Replace AirGlow"

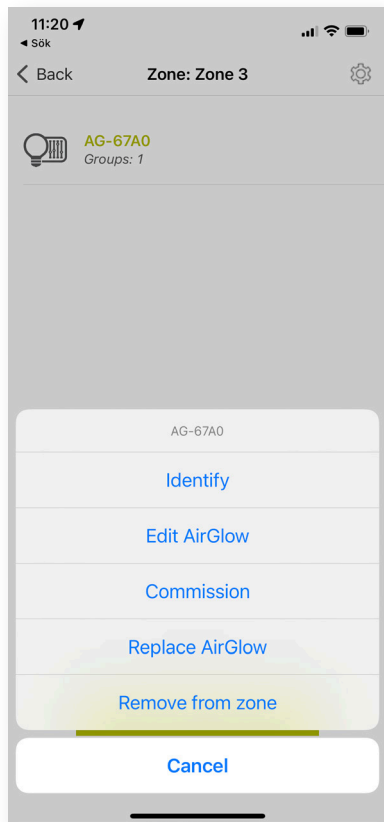

2. Choose the replacement AirGlow when it is found in the app. When selected it will identify by flashing the luminaire on/off. Make sure the correct AirGlow identifies. Now press commission. The app will now send the stored configuration from the malfunctioning AirGlow to the replacement AirGlow.

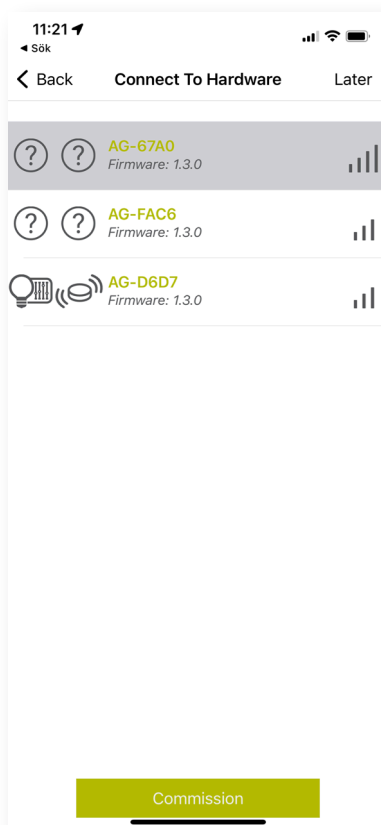

3. Navigate to the scene view and tap the scenes and chose "Send Scene to AirGlow"



ELECTRICAL SPECIFICATIONS

Parameter	Min	Nominal	Max	Unit of measure
Supply voltage	18	24	30	VDC
Power consumption		25	50	mW
LSI and DALI voltage range	0		27	VDC
LSI high level input voltage	15			VDC
LSI low level input voltage	0		7	VDC
DALI high level input voltage	9.5			VDC
DALI low level input voltage			6.5	VDC

Features

- Zhaga book 18 compliant hardware
- Astronomical time scene trigger
- Time triggering of scenes
- Presence detection through LSI interface
- Use smartphone app to set up scenes and groups
- Up to 6ch DALI DT6; refer to manual for further details
- Support for multiple DALI drivers

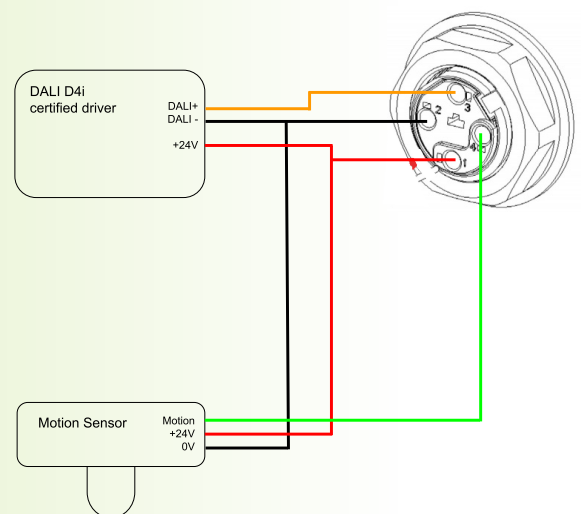

TROUBLESHOOTING

Q: I'm experiencing Bluetooth communication problems with the AirGlow application on my Android device.

A: To avoid any Bluetooth communication errors, LumenRadio recommends using Android 12 or higher and not using older generation telephones.

- Ensure that you are within 12m of the luminaire
- Ensure that the AirGlow LED is lit green
- Check that your Bluetooth on your smartphone is activated

Q: The AirGlow is powered, a green LED indicator illuminates, but I can't identify my luminaire.

A: Make sure you are in range of the AirGlow

A: Check the luminaire specification for DALI PSU which is required for proper operation.

A: Open the luminaire and check loose wiring on the Zhaga connector.

Q: I can identify the luminaire with AirGlow but when trying to create a scene I can't set colors.

A: Check the "DALI port configuration" in Edit AirGlow view so that it is set to the right number of color channels.

A: Run "Test Light Channels" in app so that all colors have been configured properly. If one or more colors are missing run "Configure Light Channels" in app.

Q: I cannot connect to my AirGlow even when I'm close to it and know it has power

A: If wiring and power is OK the AirGlow unit is probably malfunctioning. Replace the faulty AirGlow and do a "Replace AirGlow" in the app.

Please refer to "Replacement of AirGlow" on page 24.¹

MEASUREMENTS



COMPLIANCE INFORMATION

- CE/RED
- Radio: EN300328 v2.2.2
- EMC: EN 301 489-1, EN 301 489-3, EN 301 489-17
- Electrical safety: EN 62311, EN 62368-1+A11, EN 60950-22
- Environmental: IEC 60068-1, IEC 60068-2
- Test FC, Vibration: IEC 60068-2-6:2007

NOTIFICATIONS

- Do not apply mains power directly to the device.
Do not cover the device during operation or mount the node below the luminaire.
- Mount the AirGlow as horizontal as possible for best functionality.
- Make sure that the AirGlow is not damaged during shipment and handling.
- The AirGlow is for outdoor use. It has no protection against aggressive chemicals.
- Make sure that the AirGlow is not covered by metal to allow expected radio reception and communication.



With patented technologies, a unique operating system and state of the art radio modules LumenRadio provides ultra-reliable mesh connectivity for the most business critical applications.

CONTACT

Headquarters

 **Sweden, Gothenburg**
LumenRadio AB
Svangatan 2B
416 68 Göteborg

+46 31 301 03 70
sales@lumenradio.com

Sales offices

 **Germany, Frankfurt**
+49 619 658 655 590
sales@lumenradio.com

 **US, Boston**
+1 (617) 650-2651
sales@lumenradio.com